



Physical Property Measurement System

AC Measurement System (ACMS) Option User's Manual

Part Number 1084-100 C-1

Quantum Design

11578 Sorrento Valley Rd.
San Diego, CA 92121-1311
USA

Technical support (858) 481-4400
 (800) 289-6996
 Fax (858) 481-7410

Fourth edition of manual completed June 2003.

Trademarks

All product and company names appearing in this manual are trademarks or registered trademarks of their respective holders.

U.S. Patents

4,791,788 Method for Obtaining Improved Temperature Regulation When Using Liquid Helium Cooling
4,848,093 Apparatus and Method for Regulating Temperature in a Cryogenic Test Chamber
5,311,125 Magnetic Property Characterization System Employing a Single Sensing Coil Arrangement to Measure AC Susceptibility and DC Moment of a Sample (patent licensed from Lakeshore)
5,647,228 Apparatus and Method for Regulating Temperature in Cryogenic Test Chamber
5,798,641 Torque Magnetometer Utilizing Integrated Piezoresistive Levers

Foreign Patents

U.K. 9713380.5 Apparatus and Method for Regulating Temperature in Cryogenic Test Chamber

C O N T E N T S

Table of Contents

PREFACE

Contents and Conventions	vii
P.1 Introduction	vii
P.2 Scope of the Manual	vii
P.3 Contents of the Manual	vii
P.4 Conventions in the Manual	viii

CHAPTER 1

Introduction	1-1
1.1 Introduction	1-1
1.2 Theory of Operation	1-1
1.2.1 Probe Magnetism	1-2
1.2.2 Probe Thermometry	1-4
1.2.3 ACMS Electronics	1-4
1.3 System Safety	1-5
1.3.1 Magnet Safety	1-5
1.3.2 Cryogenic Safety	1-5
1.3.3 Electric Safety	1-6

CHAPTER 2

Hardware Installation	2-1
2.1 Introduction	2-1
2.2 Installing the Hardware	2-1
2.2.1 Prepare for Installation	2-2
2.2.2 Install the ACMS Insert	2-2
2.2.3 Install the ACMS Sample Transport	2-3
2.2.4 Connect the System	2-4
2.2.5 Activate the Option	2-4
2.3 Removing the Hardware	2-5
2.3.1 Prepare for Removal	2-5
2.3.2 Remove the ACMS Sample Transport	2-5
2.3.3 Remove the ACMS Insert	2-5

CHAPTER 3

Sample Installation	3-1
3.1 Introduction	3-1
3.2 Mounting the Sample	3-1
3.2.1 Method 1: Mounting a Sample on the ACMS Sample Holder	3-2
3.2.2 Method 2: Mounting a Sample on a Drinking Straw	3-3
3.3 Installing the Sample	3-4
3.4 Removing the Sample	3-5

CHAPTER 4

Measurements	4-1
4.1 Introduction	4-1
4.2 Overview of ACMS Measurements.....	4-1
4.2.1 AC Susceptibility Measurement Process	4-2
4.2.2 DC Magnetization Measurement Process.....	4-3
4.2.3 Choosing a Measurement Method	4-3
4.2.4 Operating Modes	4-4
4.3 Centering the Sample.....	4-5
4.3.1 Sample Centering Process	4-6
4.3.2 Centering the Sample with the AC Excitation Method	4-7
4.3.2.1 Centering the Sample in Immediate Mode	4-7
4.3.2.2 Centering the Sample in Sequence Mode.....	4-8
4.3.3 Centering the Sample with the DC Extraction Method	4-8
4.3.3.1 Centering the Sample in Immediate Mode	4-8
4.3.3.2 Centering the Sample in Sequence Mode.....	4-9
4.3.4 Specifying the Sample Location.....	4-9
4.3.5 Moving the Sample.....	4-10
4.4 Taking ACMS Measurements	4-11
4.4.1 Taking AC Susceptibility Measurements	4-11
4.4.1.1 Taking a Measurement in Immediate Mode	4-11
4.4.1.2 Taking a Measurement in Sequence Mode.....	4-13
4.4.1.3 Limitation of the Applied AC Field Due to Eddy Current Heating.....	4-16
4.4.2 Taking DC Magnetization Measurements	4-17
4.4.2.1 Taking a Measurement in Immediate Mode	4-17
4.4.2.2 Taking a Measurement in Sequence Mode.....	4-19

CHAPTER 5

Hardware	5-1
5.1 Introduction	5-1
5.2 Overview of Hardware	5-1
5.3 ACMS Hardware	5-2
5.3.1 ACMS Insert.....	5-2
5.3.1.1 Storage.....	5-2
5.3.2 ACMS Sample Transport	5-3
5.3.2.1 Maintenance.....	5-3
5.3.3 ACMS Sample Holder Assembly	5-4
5.3.3.1 Maintenance.....	5-5
5.3.4 AC Board.....	5-5
5.3.5 Servo Controller	5-6
5.3.6 Sample Transport/Servo Controller Cable.....	5-6
5.3.7 Model 6000/Servo Controller Cable.....	5-7
5.3.8 Preamp Cable.....	5-7

CHAPTER 6

Software	6-1
6.1 Introduction	6-1
6.2 Overview of the ACMS Software	6-1
6.2.1 ACMS Control Center	6-1
6.2.1.1 Datafile Tab	6-2
6.2.1.2 Sample Tab	6-3
6.2.1.3 Properties Tab.....	6-4

6.2.1.4 Waveforms Tab	6-4
6.2.1.5 Advanced Tab.....	6-5
6.2.1.6 Configure Tab.....	6-6
6.2.1.7 Measurement Command Buttons.....	6-6
6.3 ACMS Status Log.....	6-7
6.4 ACMS Data Files	6-7
6.4.1 Creating an ACMS Measurement Data File	6-8
6.4.2 Adding a Comment to an ACMS Measurement Data File	6-9
6.4.3 Changing ACMS Data Files during a Sequence Run	6-9

APPENDIX A

Error and Warning Messages	A-1
A.1 Introduction	A-1
A.2 System Start-Up Error and Warning Messages	A-2
A.3 General Error and Warning Messages.....	A-3
A.4 Centering Error and Warning Messages.....	A-3
A.5 AC Measurement Error and Warning Messages	A-4
A.6 DC Measurement Error and Warning Messages	A-4
A.7 DSP I/O Error and Warning Messages.....	A-5
A.8 Servo Controller Error and Warning Messages.....	A-5

References.....	References-1
------------------------	---------------------

Index	Index-1
--------------------	----------------

Figures

Figure 1-1. ACMS Insert and Coil Set	1-3
Figure 2-1. Installing the ACMS Insert	2-2
Figure 2-2. Installing the ACMS Sample Transport on a System without High Vacuum.....	2-3
Figure 2-3. ACMS Connections	2-4
Figure 3-1. ACMS Sample Holder Assembly	3-2
Figure 3-2. Correctly Positioned Sample.....	3-3
Figure 3-3. Installing the Sample	3-4
Figure 4-1. Locate Sample Dialog Box with AC Excitation Option Selected.....	4-6
Figure 4-2. Example of Plot of AC Centering in Waveforms Tab	4-7
Figure 4-3. Locate Sample Sequence Command Dialog Box with AC Excitation Option Selected.....	4-8
Figure 4-4. Example of Plot of DC Centering in Waveforms Tab	4-9
Figure 4-5. AC Magnetization Dialog Box.	4-11
Figure 4-6. Example Plot of AC Measurement in Waveforms Tab	4-13
Figure 4-7. Measure Tab in AC Magnetization Sequence Command Dialog Box.....	4-14
Figure 4-8. Scan AC Field Dialog Box	4-14
Figure 4-9. Scan Frequency Dialog Box	4-15
Figure 4-10. ACMS View Tree	4-15
Figure 4-11. PPMS Data Tab in AC Magnetization Sequence Command Dialog Box.....	4-16
Figure 4-12. DC Magnetization Dialog Box.	4-18
Figure 4-13. Example Plot of DC Measurement in Waveforms Tab	4-18
Figure 4-14. Measure Tab in DC Magnetization Sequence Command Dialog Box.....	4-19
Figure 5-1. ACMS Insert	5-2
Figure 5-2. ACMS Sample Transport.....	5-3
Figure 5-3. ACMS Sample Holder Assembly	5-5
Figure 5-4. ACMS Servo Controller	5-6
Figure 5-5. Sample Transport/Servo Controller Cable.....	5-7
Figure 5-6. Model 6000/Servo Controller Cable.....	5-7
Figure 5-7. ACMS Preamp Cable.....	5-7
Figure 6-1. Datafile Tab in ACMS Control Center	6-2
Figure 6-2. Sample Tab in ACMS Control Center	6-3
Figure 6-3. Waveforms Tab in ACMS Control Center	6-4
Figure 6-4. Advanced Tab in ACMS Control Center.....	6-5
Figure 6-5. Configure Tab in ACMS Control Center.....	6-6
Figure 6-6. ACMS Status Log.....	6-7
Figure 6-7. ACMS Datafile Comment Dialog Box	6-9
Figure 6-8. Datafile Tab in Change Datafile Dialog Box.....	6-10

Tables

Table 4-1. Measure Modes for AC Susceptibility Measurements	4-12
Table 4-2. Amplitude Spacing Modes	4-14
Table 4-3. Frequency Spacing Modes	4-15
Table 4-4. Maximum AC Field Amplitude (Oe) to Avoid Warming	4-17
Table 5-1. ACMS Mounting Options	5-5

Contents and Conventions

P.1 Introduction

This preface contains the following information:

- Section P.2 discusses the overall scope of the manual.
- Section P.3 briefly summarizes the contents of the manual.
- Section P.4 illustrates and describes conventions that appear in the manual.

P.2 Scope of the Manual

This manual discusses the operation of the AC Measurement System (ACMS) option hardware and software and explains how to take ACMS measurements.

For detailed information about the PPMS MultiVu application, which is the software running the Physical Property Measurement System (PPMS), refer to the *Physical Property Measurement System: PPMS MultiVu Application User's Manual*. The ACMS software is integrated into PPMS MultiVu.

P.3 Contents of the Manual

- Chapter 1 discusses the theory of operation for the ACMS option.
- Chapter 2 explains how to install and remove the ACMS hardware.
- Chapter 3 explains how to mount, install, and remove samples.
- Chapter 4 explains how to take ACMS measurements.
- Chapter 5 discusses the ACMS hardware and maintenance issues.
- Chapter 6 discusses the ACMS software and ACMS data files.
- Appendix A lists error and warning messages.

P.4 Conventions in the Manual

File menu Bold text distinguishes the names of menus, options, buttons, and panels appearing on the PC monitor or on the Model 6000 PPMS Controller LCD screen.

File>Open The ► symbol indicates that you select multiple, nested software options.

STATUS Bold text and all capital letters distinguish the names of keys located on the front panel of the Model 6000 PPMS Controller.

`.dat` The Courier font distinguishes characters you enter from the PC keyboard or from the Model 6000 PPMS Controller front panel. The Courier font also distinguishes code and the names of files and directories.

<Enter> Angle brackets distinguish the names of keys located on the PC keyboard.

<Alt+Enter> A plus sign connecting the names of two or more keys distinguishes keys you press simultaneously.



A pointing hand introduces a supplementary note.



An exclamation point inside an inverted triangle introduces a cautionary note.



A lightning bolt inside an inverted triangle introduces a warning.

Introduction

1.1 Introduction

This chapter contains the following information:

- Section 1.2 discusses the theory of operation for the ACMS option.
- Section 1.3 discusses how to safely operate the ACMS and PPMS systems.

1.2 Theory of Operation

The Quantum Design AC Measurement System (ACMS) option for the Physical Property Measurement System (PPMS) is a versatile DC magnetometer and AC susceptometer. The state-of-the-art technology of the ACMS offers extensive susceptibility and magnetization capabilities while retaining a user-friendly environment. By being connected to the automated temperature and field control systems of the PPMS, the ACMS provides a highly powerful, fully automated magnetic workstation.

The ACMS insert houses the drive and detection coils, thermometer, and electrical connections for the ACMS system. The insert fits directly in the PPMS sample chamber and contains a sample space that lies within the uniform magnetic field region of the host PPMS, so DC field and temperature control can be performed with conventional PPMS methods. The sample is held within the insert's coil set on the end of a thin, rigid sample rod. The sample holder is translated longitudinally by a DC servo motor located in the ACMS sample transport assembly. The DC servo motor provides rapid and very smooth longitudinal sample motion. The ACMS sample transport assembly mounts on top of the PPMS probe.

1.2.1 Probe Magnetics

The ACMS contains an AC-drive coil set that provides an alternating excitation field and a detection coil set that inductively responds to the combined sample moment and excitation field. The copper drive and detection coils are situated within the ACMS insert, concentric with the superconducting DC magnet of the PPMS. Refer to figure 1-1.

The drive coil is wound longitudinally around the detection coil set. The field amplitude that can be applied depends on the frequency of the alternating field and the temperature within the PPMS probe, but, at any temperature, the drive coil can generate alternating fields of up to ± 10 Oe in a frequency range of 10 Hz to 10 kHz. As the frequency and temperature decrease, larger amplitude fields can be applied. At temperatures below 25 K, large amplitude fields can warm the PPMS sample chamber and ACMS insert. See section 4.4.1.3 for more information.

The detection coils are arranged in a first-order gradiometer configuration to help isolate the sample's signal from uniform background sources. This configuration utilizes two sets of counterwound copper coils connected in series and separated by several centimeters. During DC measurements, a constant field is applied to the measurement region and the sample is moved quickly through both sets of coils, inducing a signal in them according to Faraday's Law. This measurement method is commonly called the extraction method. During AC measurements, an alternating field is applied to the measurement region and the sample is positioned in the center of each detection coil. The detection coils indicate how the applied field is altered by the presence of the sample.

A compensation coil is situated outside the AC drive coil. The drive coil and compensation coil are counterwound and connected in series so that they receive the same excitation signal. A net field remains within the measurement region, but outside the measurement region the fields from the two coils tend to cancel. The compensation coil actually reduces dipole fields to quadropole fields. It effectively confines the excitation fields to the volume of the coil set, thereby reducing instrument interaction with conductive materials outside the measurement region—that is, the sample chamber walls, the magnet core, and so on—by three orders of magnitude. Each ACMS system is individually calibrated so that the drive coil and compensation coil produce the appropriate net excitation signal at the sample.

Each detection coil also contains a low-inductance calibration coil. These two single-turn calibration coils are connected in series and are situated at the center of each detection coil, where the sample measurements occur. During AC measurements, the accuracy of the phase and amplitude calibration is increased by placing the sample between the two detection coils and switching the calibration coils into the detection coil circuit with both possible polarities. The calibration coil is a feature found only on the Quantum Design ACMS.



CAUTION

Do not expose the ACMS coil set to temperatures greater than 350 K. The thermometers are calibrated only for temperatures below 350 K, and operation above 350 K is excluded from the system warranty.



CAUTION

If the coil set is accidentally exposed to temperatures greater than 350 K, remove the ACMS insert from the PPMS only after the insert has thoroughly cooled. If the insert is removed while it is still hot, some of its components may break off.

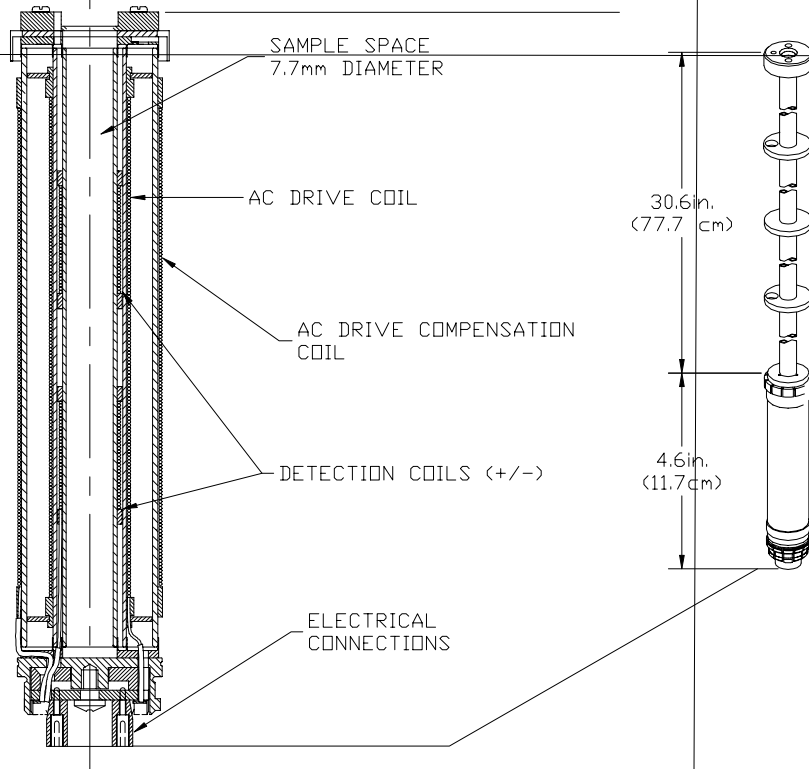

1.2.2 Probe Thermometry

The ACMS insert is thermally anchored to the base of the PPMS sample chamber. In this way the automated temperature control capabilities of the PPMS are used to control the temperature of the ACMS sample chamber.

In addition to the PPMS thermometers, the ACMS has a thermometer mounted directly on its coil form. This thermometer helps reduce errors from thermal time-constants that may exist at higher temperatures. The sample maintains close thermal contact with the ACMS thermometer by using the low-pressure helium vapor inside the PPMS sample chamber. This design gives fast thermal response times. The fast thermal response, precise temperature control hardware, and automation software provide accurate, time-efficient, user-friendly thermometry.

1.2.3 ACMS Electronics

The ACMS coils are connected to the PPMS electronics through the 12-pin connector located at the base of the PPMS sample chamber. This configuration uses the existing electronic wiring that is built into the PPMS hardware, thus eliminating the need for additional wiring and connectors.

The ACMS option includes an AC board, which is installed in the Model 6000 PPMS Controller. The AC board provides the electronics that produce the desired excitation current in the drive coils, and it also effectively measures and separates the real and imaginary components of the sample's magnetic response. The heart of the AC board is a digital signal processor (DSP) that synthesizes the excitation signal and processes the detection coils' response signal.

The ACMS also includes a servo controller box. The servo controller box contains the electronics that control the ACMS sample transport servo motor.

1.3 System Safety

The *Physical Property Measurement System: Hardware Manual* summarizes safety considerations for PPMS usage. These safety precautions also apply to the ACMS option. In general, use common sense around the PPMS and ACMS just as you would around any other laboratory equipment. Make certain that inexperienced PPMS users are supervised.

1.3.1 Magnet Safety

Observe the following precautions for magnet safety. Also make certain you review the material in chapter 1 in the *Physical Property Measurement System: Hardware Manual*.



WARNING

Large magnetic fields are dangerous to anyone wearing a pacemaker or other electrical medical device. Make certain any person wearing a pacemaker or similar device stays at least 3.0–4.5 m (10–15 ft.) from the PPMS dewar whenever the PPMS superconducting magnet is charged.



WARNING

Large magnets, such as the PPMS superconducting magnets, can attract iron and other ferromagnetic materials with great force. Keep all iron, nickel, and other ferromagnetic objects at least 5.0 m (16.5 ft.) from the PPMS dewar.

The observable effects of magnetic fields are listed in chapter 1 in the *Physical Property Measurement System: Hardware Manual*.

1.3.2 Cryogenic Safety

When you work with cryogenic materials such as liquid helium and liquid nitrogen, keep in mind that (1) they can expand when subjected to room temperature and (2) they can burn.



WARNING

The extreme cold of liquid and gaseous cryogenics can cause serious burns. Always wear protective clothing, including thermal gloves, eye protection, and covered shoes, when you work with liquid helium, liquid nitrogen, or any other cryogen.



WARNING

In a poorly ventilated room, helium can displace air and lead to asphyxiation. Always perform cryogen transfers in a well-ventilated room. In the event of a rupture or spill, vent the room immediately and evacuate all personnel.

Cryogenics stored in confined spaces are subject to extremely high pressure buildup, resulting in dangerous explosions. Pressure relief valves are installed on the PPMS dewar and cooling annulus, and rupture disks are installed on the vacuum sleeve and dewar to eliminate the possibility of explosion. *Do not remove, disable, or otherwise tamper with these safety devices.*

1.3.3 Electric Safety

The PPMS and ACMS equipment is powered by standard 110-VAC or 220-VAC power sources. These voltages are potentially lethal. Exercise appropriate care when you open any of the PPMS electronic units.

- Unplug all electronic equipment before you remove any covers.
- Keep electrical cords in good working condition, and replace frayed and damaged cords.
- Keep liquids away from the workstation.

Hardware Installation

2.1 Introduction

This chapter contains the following information:

- Section 2.2 explains how to install the ACMS hardware in the PPMS.
- Section 2.3 explains how to remove the ACMS hardware from the PPMS.

2.2 Installing the Hardware

PPMS systems shipped with the ACMS option have all controller hardware and software installed prior to shipment. The ACMS insert and ACMS sample transport are the only components requiring user installation and removal. The modular design of the ACMS option allows the ACMS insert and ACMS sample transport to be installed and removed as necessary. The instructions in this chapter explain how to install the insert and sample transport and how to activate the ACMS option.



The instructions in this chapter assume that the basic PPMS is already set up—that is, the probe inserted in the dewar, the dewar filled with helium, and the Model 6000 PPMS Controller connected to the probe and personal computer. If this is not the case, set up the PPMS as described in the *Physical Property Measurement System: Hardware Manual* before continuing.

Temperature and chamber commands may be issued from either the Model 6000 PPMS Controller or the PPMS MultiVu software application. The instructions in this chapter illustrate use of PPMS MultiVu. For detailed information about PPMS MultiVu, refer to the *Physical Property Measurement System: PPMS MultiVu Application User's Manual*.

2.2.1 Prepare for Installation

1. Set the PPMS system temperature to 298 K. You can do this as follows: (a) Select **Instrument**►**Temperature**, (b) specify a set point of 298 K, (c) specify the rate of ramping to the set point, (d) select the temperature approach mode, and (e) select **Set**. Do *not* continue with installation until the temperature reaches 298 K.
2. Vent the PPMS sample chamber. You can do this as follows: (a) Select **Instrument**►**Chamber** and (b) select the **Vent Cont.** button.
3. Remove the blank flange from the top of the PPMS probe. Removing the cover is impossible until the sample chamber is vented.
4. **Remove any sample puck or PPMS option that is installed in the sample chamber.** Refer to the *Physical Property Measurement System: Hardware Manual* to remove a sample puck. Refer to the appropriate PPMS option manual to remove an option.

2.2.2 Install the ACMS Insert

1. Attach the 4-40 thumbscrew to the top of the ACMS insert.
2. Carefully lower the ACMS insert, coil-set end first, into the PPMS sample chamber.

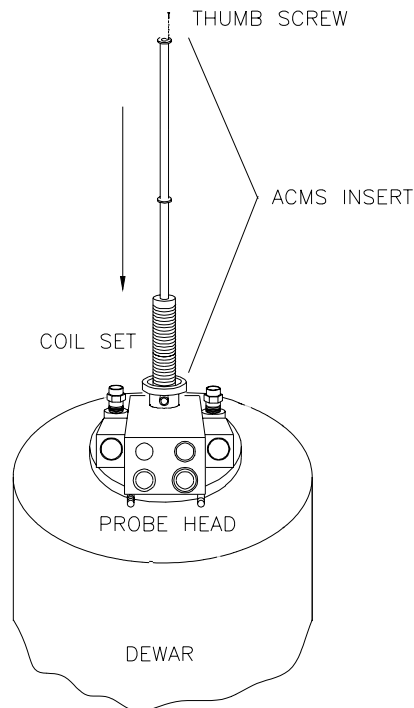

Figure 2-1. Installing the ACMS Insert

3. Correctly position the ACMS insert as follows: (a) Use the 4-40 thumbscrew to rotate the insert so that the white dot on the top of the insert faces the front of the PPMS probe—that is, the side with the Quantum Design logo; and then (b) when you feel the insert drop into place, indicating that the keyed interface at its base is properly aligned, press down on the insert until it snaps into place.
4. Remove the 4-40 thumbscrew from the ACMS insert.

2.2.3 Install the ACMS Sample Transport

1. Hold the ACMS sample transport so that the electrical port on its rear panel is oriented correctly.
 - If your PPMS *does not include* the High-Vacuum option, hold the ACMS sample transport so that the electrical port faces the rear of the PPMS probe head—that is, away from the Quantum Design logo. Refer to figure 2-2.
 - If your PPMS *does include* the High-Vacuum option, hold the ACMS sample transport so that the electrical port faces the front of the PPMS probe head—that is, toward the Quantum Design logo.
2. Swing out the two legs on the bottom of the ACMS sample transport. If your PPMS includes the High-Vacuum option, angle the legs in order to avoid hitting the pop-off valves on top of the dewar.
3. Inspect the O-ring on the bottom of the ACMS sample transport. Clean the O-ring if necessary.
4. Set the ACMS sample transport on top of the flange opening.
5. Clamp the two transport legs shut. Verify that the legs snap into place so that they engage pressure with the O-ring.
6. Verify that the O-ring mating with the probe flange is properly seated in the probe flange.
7. Verify that the small, black cap is correctly positioned on top of the sample transport.

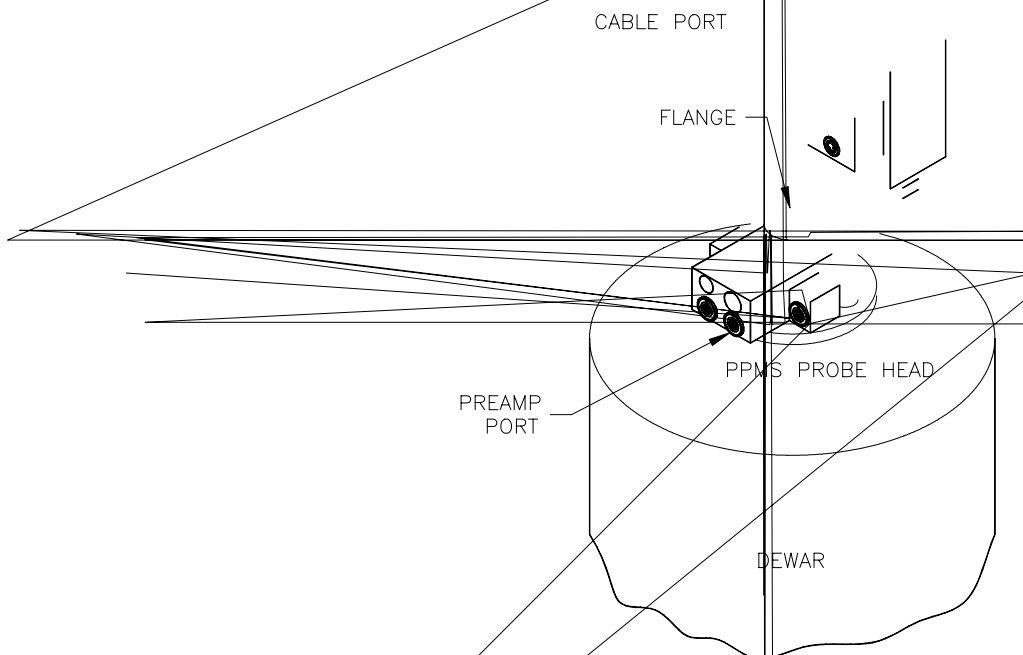
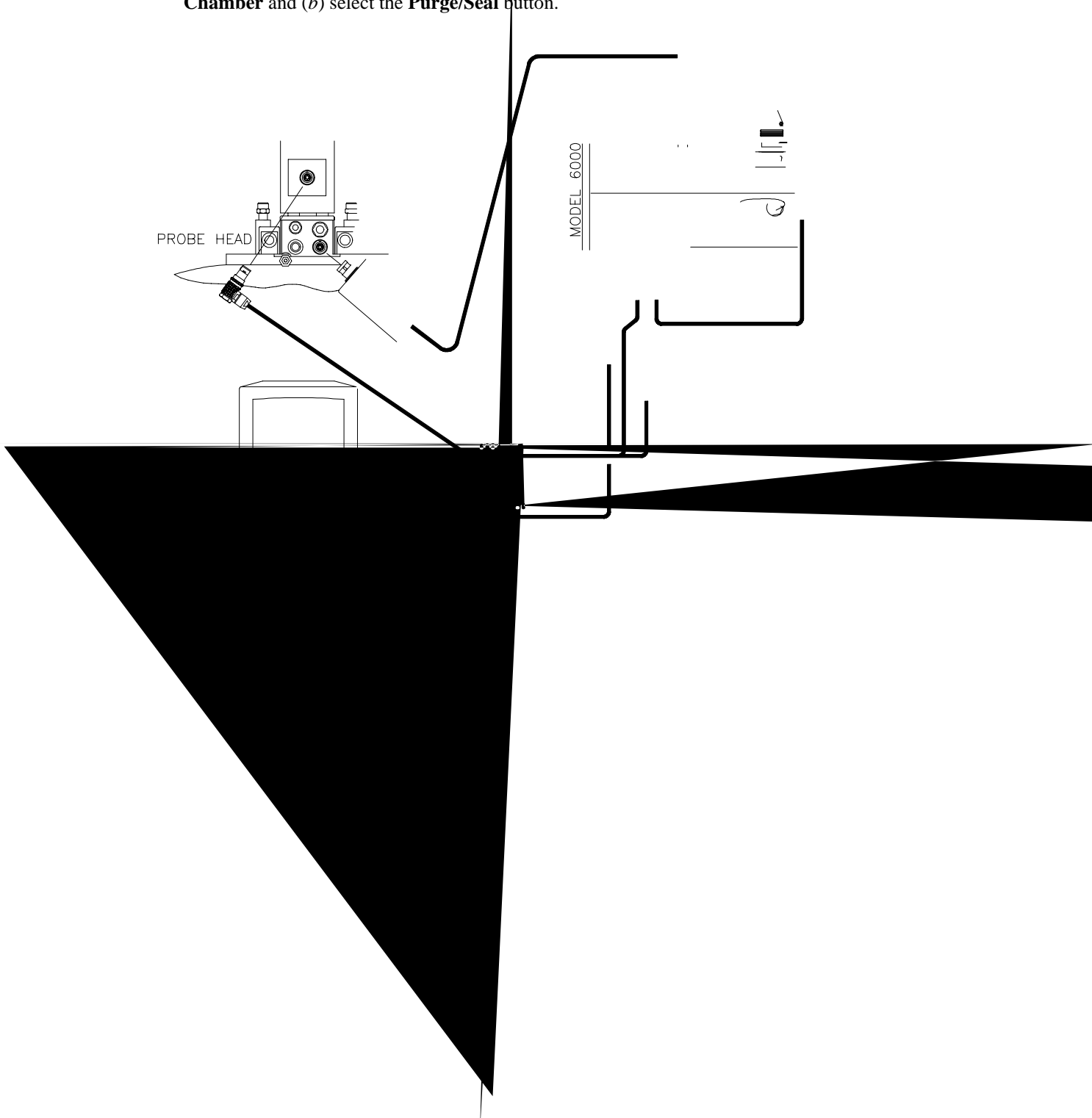

Figure 2-2. Installing the ACMS Sample Transport on a System without High Vacuum

2.2.4 Connect the System

1. Complete the electrical connections for the ACMS option as shown in figure 2-3. Make certain that you screw all connectors solidly into place.
If a user bridge board is connected to the PPMS, you must unplug the user bridge board cable from the probe head in order to accommodate the ACMS preamp.
2. Purge and seal the PPMS sample chamber. You can do this as follows: (a) Select **Instrument► Chamber** and (b) select the **Purge/Seal** button.



2.3 Removing the Hardware

The ACMS insert and ACMS sample transport should be removed from the PPMS when the system will not be used. The procedure for removing the insert and sample transport is essentially the reverse of the installation procedure.

When the ACMS insert is not in place inside the sample chamber, it should be stored in such a way that it is either hanging from the top end-support or resting horizontally with support along its length.

2.3.1 Prepare for Removal

1. Set the PPMS system temperature to 298 K. You can do this as follows: (a) Select **Instrument**►**Temperature**, (b) specify a set point of 298 K, (c) specify the rate of ramping to the set point, (d) select the temperature approach mode, and (e) select **Set**. Do *not* continue with the removal procedure until the temperature reaches 298 K.
2. Vent the PPMS sample chamber. You can do this as follows: (a) Select **Instrument**►**Chamber** and (b) select the **Vent Cont.** button.
3. Remove the sample and sample holder from the ACMS insert. Refer to section 3.4.

2.3.2 Remove the ACMS Sample Transport

1. Disconnect the sample transport/servo cable from the ACMS sample transport. The cable may remain connected to the servo controller box. Refer to figure 2-3.
When you disconnect the sample transport/servo cable, the sample chamber will vent.
2. Remove the ACMS sample transport from the PPMS probe.

2.3.3 Remove the ACMS Insert

1. Attach the 4-40 thumbscrew to the top of the ACMS insert.
2. Use the thumbscrew to carefully lift the insert out of the probe. Set the insert in a safe place according to the system care instructions in section 5.3.1.1.
3. Return the blank flange to the top of the probe head, or install another PPMS option.
4. Unplug the preamp from the PPMS probe head. Refer to figure 2-3.
5. Do one of the following: Either (a) verify that the blank flange is properly positioned and the clamp is installed or (b) verify that the sample chamber is sealed.
6. Purge and seal the PPMS sample chamber. You can do this as follows: (a) Select **Instrument**►**Chamber** and (b) select the **Purge/Seal** button.

Sample Installation

3.1 Introduction

This chapter contains the following information:

- Section 3.2 explains two popular methods for mounting samples for ACMS measurements.
- Section 3.3 explains how to insert a sample into the ACMS insert.
- Section 3.4 explains how to remove a sample from the ACMS insert.

3.2 Mounting the Sample

Samples for ACMS measurements may be mounted directly on the ACMS sample holder or on a clear plastic drinking straw. Refer to sections 3.2.1 and 3.2.2, respectively. Clear plastic drinking straws are available from Quantum Design.



The material out of which the ACMS sample rod is constructed has susceptibility $< 2 \times 10^{-7}$ and can be detected by the ACMS. A clear plastic drinking straw, on the other hand, adds a negligible magnetic moment that is below the instrument's noise floor. However, unlike a drinking straw, the bucket on the ACMS sample holder can accommodate powered samples.

3.2.2 Method 2: Mounting a Sample on a Drinking Straw

1. Cut off a small section of a clear plastic drinking straw. The section must be small enough to fit lengthwise inside the straw.
2. Place the sample inside the small straw section, as in figure 3-2. Quantum Design recommends that you use Teflon-coated tweezers for this step. Placing the sample in the correct orientation can be difficult, so this step may take some practice.
3. Insert the sample and small straw section inside the straw so that the openings of the small straw section are obstructed by the walls of the larger straw.
4. Verify that the sample is secure and will not vibrate or shift. The sample may be subjected to high-speed motion during the measurement.
5. Puncture three or four small holes in the upper portion of the straw (about 2.5 cm or 1 inch from the end) to allow air to escape during sample chamber evacuation.

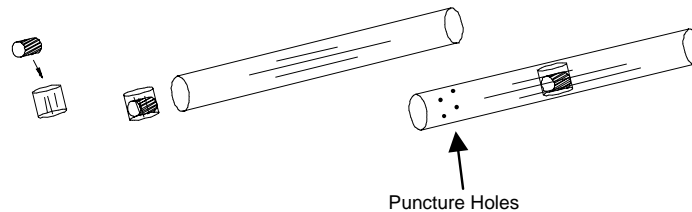

Figure 3-2. Correctly Positioned Sample

6. Remove the short sample rod from the ACMS sample holder by gently rotating it relative to the long sample rod.
7. Position the sample so that it is about $4\frac{1}{8}$ inch (10.5 cm) from the bottom of the long sample rod. This ensures that the sample is positioned near the center of the detection coils.
8. Use a straw adapter to allow the straw to fit snugly over the threads.
9. Secure the straw to the long sample rod.
10. Cut off the excess straw below the sample. This portion of the straw is subject to contact with the end of the ACMS insert which prohibits full sample motion during ACMS operation.
11. Place a small piece of tape over the bottom end of the straw. This is intended to prevent the sample from falling into the chamber if it comes loose from the sample holder.

The sample is now ready to be installed in the ACMS insert.

You may find other means of mounting samples that will work better for your particular application.

3.3 Installing the Sample



The sample may be installed in the ACMS insert only if the ACMS hardware is installed and the ACMS option is activated in the PPMS MultiVu software. Refer to chapter 2 to install and activate the ACMS option.

1. Mount the sample on the ACMS sample holder or on a clear plastic drinking straw as described in section 3.2.1 or 3.2.2, respectively.
2. Set the system temperature to 298 K. Do *not* continue with the sample installation until the system reaches room temperature. Otherwise, ice may accumulate within the sample chamber and block sample motion.
3. Select the **Sample** tab in the ACMS control center (see figure 6-2).
4. Select the **Change** button in the **Sample** tab. The sample space is vented with helium. This protects the system from contamination and ice accumulation and enables sample holder insertion.
5. Remove the small, black cap from the sample chamber access port on the ACMS sample transport. Place the cap on the cap holder for safe storage.
6. Lower the ACMS sample holder, sample end first, through the sample chamber access port on the top of the ACMS sample transport. Insert the sample holder completely into the sample chamber. As you lower the sample holder, it may be helpful to twist it in order to guide the baffles into place.
7. Snap the sample holder into place by lightly pressing down on its black end-cap.
8. Return the cover to the sample transport.
9. Select the **Finished** button in the **Sample** tab.

When you select **Finished**, the PPMS performs a purge sequence to remove air from the sample chamber. In addition, the ACMS sample transport moves through its full travel length to ensure that its path is unobstructed.

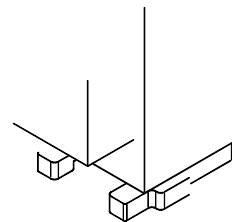

You must select the **Finished** button before you run any measurements. If you try to run a measurement before you select **Finished**, the software displays an error message.

If sample insertion is not completed within 90 seconds, the servo motor is turned off to prevent it from overheating. To turn the servo motor back on and complete the sample insertion, you select the **Motor On** button in the **Sample** tab. Notice that you must still select **Finished** after you select **Motor On**.

If the sample offers a large resistance to the gas flow of the purge sequence, the strong suction forces are indistinguishable from an obstruction, and the software may erroneously report an obstruction. If an obstruction is detected, you are prompted to cancel the insertion or retry. If you elect to reinsert the sample, the sample space is vented to allow you to remove the cover and repeat the sample-loading process. Once the sample is reinserted, press the **OK** button to complete the installation process.

3.4 Removing the Sample

1. Set the system temperature to 298 K. Do *not* continue with the sample removal until the system reaches room temperature. Otherwise, ice may accumulate within the sample chamber and block sample motion.
2. Select the **Sample** tab in the ACMS control center (see figure 6-2).
3. Select the **Change** button in the **Sample** tab. The system immediately prepares for sample removal by venting the sample chamber.
4. Remove the sample transport cover and place it on the smaller black cap for safe storage. Refer to figure 3-3.
5. Grip the small black cap on the sample holder assembly and then remove the sample holder assembly from the ACMS sample chamber. It may be helpful to twist the sample holder as you raise it to guide the baffles through the openings.
6. Return the cover to the sample transport.
7. Press the **Finished** button in the **Sample** tab.

If sample removal is not completed within 90 seconds, the servo motor is turned off to prevent it from overheating. To turn the servo motor back on and complete the sample removal, you select the **Motor On** button in the **Sample** tab. Notice that you must still select **Finished** after you select **Motor On**.

Measurements

4.1 Introduction

This chapter contains the following information:

- Section 4.2 describes the AC and DC measurement processes and compares these two measurement types.
- Section 4.3 describes the AC and DC centering methods and explains how to center the sample.
- Section 4.4 explains how to perform AC and DC measurements.

4.2 Overview of ACMS Measurements

The ACMS is both a DC magnetometer and an AC susceptometer. The distinction between the two types of measurements is important. DC magnetization measurements measure a sample's magnetic moment in an applied magnetic field at a specific temperature. AC susceptibility measurements do not directly measure a sample's magnetic moment and are far more sensitive. Section 4.2.1 describes the AC susceptibility measurement process. Section 4.2.2 describes the DC magnetization measurement process. Section 4.2.3 discusses some factors to consider when you are deciding what type of measurement to take.

Once the ACMS is electronically connected to the Model 6000, it is fully configured to perform both AC susceptibility and DC magnetization measurements. No hardware or software reconfiguration is necessary to switch from AC susceptibility to DC magnetization. In fact, you can actually perform both measurements on a sample within a single sequence. To save time, both AC susceptibility and DC magnetization can be measured at each measurement step. If the magnetization criteria are different from the susceptibility criteria, the sequence can be configured to perform each measurement individually, yet within a single sequence.



Before a sample is measured for the first time, it should be centered relative to the detection coils that are in the ACMS insert. Section 4.3 discusses centering methods.

4.2.1 AC Susceptibility Measurement Process

AC susceptibility measurements do not directly measure a sample's magnetic moment. Samples with very different magnetic moments can have the same response to a changing magnetic field if their susceptibilities are the same in the measurement regimes of interest. The AC susceptibility option in the ACMS adds a small alternating field to the large applied field from the PPMS superconducting magnet and measures a sample's magnetic moment response. Both the amplitude and phase of this response are reported. Alternatively, the ACMS can report the in-phase and quadrature components of the sample's response. Note that the reported amplitude is the amplitude of the *change* in magnetic moment dM and is not an absolute magnetic moment or a susceptibility. To obtain the AC susceptibility, you must divide the amplitude of the change in moment by the amplitude of the alternating field dH . This gives

$$\chi_{ac} = dM/dH.$$

Remember that this is only the local slope of the sample's magnetization curve $M(H)$ and not the "true" susceptibility

$$\chi = M/H.$$

It is important to note the difference between AC susceptibility and "true" susceptibility when dealing with samples that have non-linear magnetization curves.

During an AC susceptibility measurement, an alternating magnetic field is applied to the measurement region by itself or in addition to the constant field applied by the PPMS superconducting magnet. This alternating field is synthesized by the AC board's DSP and sent to a digital-to-analog converter. The analog signal is amplified in order to excite the drive and compensation coils.

By default, the sample undergoes a five-point measurement process that utilizes the calibration coil to increase measurement accuracy. The first reading is made with the sample positioned in the center of the bottom detection coil. Then the sample is positioned in the center of the top detection coil, and then in the center of the bottom coil again. During all three readings, the signals from the detection coil array are amplified, low-pass filtered, and digitized by an analog-to-digital converter (A/D). These signals are stored as waveform blocks in the data buffer. All 128 buffer points are used to record each response waveform. The points are fitted and compared to the driving signal to determine the real and imaginary components of the response when the sample is in the center of each detection coil. (Imaginary components are in phase with the driving signal and real components are 90° out of phase with the driving signal.) Subtracting one reading from the other gives a sample vector in the complex plane.

When the bottom-top-bottom coil readings are complete, the sample is placed at the center of the detection coil array so that it is between the two detection coils. Two more readings are taken with the calibration coil switched into the detection circuit with opposing polarities. The real and imaginary components of each response waveform are obtained by again fitting the data and comparing it to the driving signal. The two calibration readings are subtracted to yield a calibration vector in the complex plane. Subtracting the two calibration readings subtracts out the sample signal, leaving only environmental and instrumental factors that affect the reading. The calibration vector is used to accurately place the sample vector at the origin with the proper orientation and scaling. The true values of interest for the sample are then reported, either as moment amplitude and phase (magnitude and angle of the sample vector) or as in-phase and out-of-phase (or quadrature) components of the moment (real and imaginary components of the sample vector.) Notice that in-phase components of the response signal are *in phase* with the *ideal* response signal, which is 90° *out of phase* with the *driving* signal. This is due to the nature of Faraday's law. During each measurement, several waveform blocks can be measured and averaged to reduce random noise that may be present in the signal.

4.2.2 DC Magnetization Measurement Process

DC magnetization measurements measure a sample's magnetic moment M in an applied magnetic field H at a specific temperature T ($M = M(H, T)$). The ACMS does not use Quantum Design SQUID technology to perform DC magnetization measurements. Instead, it moves the sample through a set of copper coils and analyzes the induced signal with a digital signal processor (DSP) to determine the sample's magnetic moment.

During a DC magnetization measurement, the PPMS applies a constant magnetic field to the sample space, and the sample transport servo motor translates the sample through the entire detection coil set in approximately 0.05 second. To synchronize sample translation with data acquisition, the servo motor sends a handshake signal to the DSP that triggers data acquisition. The ACMS takes 4096 voltage readings during sample translation and creates a voltage profile curve for the translation. The detection coils register a voltage proportional to the rate of change of magnetic flux through them, so the voltage profile is the time derivative of the net flux through the coils. The actual sample moment is obtained by numerically integrating the voltage profile and fitting the known waveform for a dipole moving through the detection coils to the resulting data using a regression algorithm. Alternatively, the integrated data can be used to calculate the sample's center position.

4.2.3 Choosing a Measurement Method

In the ACMS option, AC measurements are nearly three orders of magnitude more sensitive than DC measurements. Conductive samples usually yield much larger signals during AC measurements. However, in some situations, DC measurements produce better results than AC measurements. For example, weakly paramagnetic samples with magnetic moments near the noise floor of the ACMS's AC measurement capability ($\sim 1 \times 10^{-8}$ emu) can often be detected more easily in the large DC fields applied by the PPMS superconducting magnet, because the larger DC field raises the sample's moment well above the noise floor for DC measurements ($\sim 2.5 \times 10^{-5}$ emu). In such cases a DC center (section 4.3.3) is appropriate. Most PPMS platforms contain at least 7-T DC magnets, while the ACMS can only apply alternating fields of up to ± 10 Oe consistently (1 T = 10,000 Oe). In addition, large or asymmetric sample holders generally require DC methods to properly account for background sources. Other symmetry and field uniformity concerns—such as small applied fields—usually demand DC methods as well.

There are many other points to consider when determining whether to use AC or DC centering and measurement methods. It is your responsibility to choose centering and measurement techniques that are appropriate for the type of information being sought and the type of sample being examined. Important sample characteristics to consider include type of magnetic behavior, magnetic moment, conductivity, shape, and size. Applied field and temperature can also be important. Finally, the nature of the information that the experiment examines should be considered. AC susceptibility measurements are fundamentally different than DC measurements in that they report a *change* in a sample's magnetic moment with a relatively small change in field, rather than a sample's absolute moment in a relatively large constant field. Contact a Quantum Design representative if you would like to discuss considerations specific to your application.

The ACMS also supports independent sample movement, because moving the sample independently of the measurement may be important for particular experiments. When the ACMS is not taking a measurement, you may move the sample to a specific location within the detection coils. Refer to section 4.3.5.

4.2.4 Operating Modes

ACMS measurements and sample centering may run in immediate mode or sequence mode. ACMS control center commands and PPMS MultiVu **Measure** menu commands execute operations immediately, but each control center or menu command must be selected manually. ACMS measurement sequence commands included in a PPMS MultiVu sequence file are executed automatically when they are read while the sequence runs. Any number and combination of measurement sequence commands may be included in a sequence file.

Data from immediate-mode measurements or sample centering is saved only if an ACMS measurement data file is selected to store the data, and once the measurement is complete, a **Save** command is issued, prompting the system to save the data to the specified file. Measurement and selected system data read during sequence mode measurements and sample centering is automatically saved to the specified data file.

The immediate-mode measurement dialog boxes show the results from the last measurement of that same type (see figure 4-5, for example). The sequence mode measurement dialog boxes do not show measurement results, but you can use them to select which system data items you want to save to the specified ACMS measurement data file (see figure 4-11).

Diagnostic plots, which appear in the **Waveforms** tab in the ACMS control center, are generated for all measurements and sample centering. To view the waveforms, you can also open ACMS raw measurement data files at any time.



NOTE

You are encouraged to use the ACMS control center to perform all normal system operations. The automated routines in the control center help ensure that you complete the necessary procedures when you install new samples and create data files. This chapter illustrates use of the control center.

The *Physical Property Measurement System: PPMS MultiVu Application User's Manual* discusses sequence files, sequence operation, and all standard PPMS sequence commands in detail.

4.3 Centering the Sample



The sample can be centered only if the ACMS hardware is installed and the ACMS option is activated in PPMS MultiVu. Refer to chapter 2 to install and activate the ACMS option.

It is advisable to center, or *locate*, the sample prior to measuring it. The sample is centered in order to determine the location the DC servo motor needs to be at to position the magnetic center of the sample in the center of the detection coil set. Knowing this center location is important. It allows the ACMS to determine the proper range of motion for DC magnetization measurements and the correct sample position relative to the detection coils for AC susceptibility measurements. As long as the sample is mounted near the center of the detection coils (approximately 10.5 ± 0.8 cm from the end of the long sample rod on the ACMS sample holder), the ACMS sample transport can automatically center it by adjusting the sample position relative to servo motor zero. There is about an 8-mm window within which the sample's magnetic center must lie in order to allow automatic centering. If the sample is not properly centered, it is difficult for the ACMS to determine the sample's true magnetic moment.

The ACMS has two distinct automatic centering methods—AC excitation (or AC centering) and DC extraction (or DC centering)—just as it has two distinct measurement types. You may want to choose a centering method based on the type of measurement you will perform, although this is not required, because measuring the sample response to an alternating field is fundamentally a more sensitive technique than moving a sample through a set of detection coils in a constant field. Consequently, you are advised to first use AC centering to center the sample; AC measurements are nearly three orders of magnitude more sensitive than DC measurements. Of course some situations are best suited to DC centering and DC measurements. In brief, the sample you are measuring and the type of response you want influence which centering method you choose. Section 4.2.3 reviews measurement considerations.

As a general rule, each sample needs to be centered only once. However, for the most precise measurements you should re-center the sample after large temperature changes. The difference in thermal expansion between the sample holder and the ACMS insert has been found to be less than 18 mm over the temperature range of 2–300 K.

You may want to re-center the sample prior to re-measuring it with a different measurement method—that is, if you are switching from AC to DC measurements or from DC to AC measurements—but this is not required.

In addition to centering the sample, you may also move it to a specific location within the detection coils. Refer to section 4.3.5.

4.3.1 Sample Centering Process

To locate the sample's center position, an alternating magnetic field is applied to the sample space and the detection coil response is recorded for 64 discrete positions as the sample is stepped through the detection coils, starting at the bottom coil. The ACMS software calculates the amplitude of the response for each point, fits a curve to the moment amplitude versus position plot of this data, and calculates the point of symmetry. That is, the point at which

$$f(x_0) = \frac{1}{2}[f(x) + f(2x_0 - x)]$$

for all x , where x_0 is the point of symmetry. In the **Locate Sample** dialog box (see figure 4-1), this position is reported as the **Center Location** value.

Both the AC and DC location methods determine **Center Location** values and **Location** values. AC centering finds the **Center Location** value first and adds the offset value in order to obtain the **Location**. DC centering first determines the **Location** and then adjusts the **Center Location** value by using the DC-AC offset.



It is important to realize that the **Center Location** value is the *true* center position, while the **Location** value is simply an apparent position value due to electronic time lag.

Whenever a DC measurement is performed, the ACMS software uses the **Location** to calculate the range of sample motion. In this way it accounts for the electronic time lag when taking DC measurements. During AC measurements the sample is at rest, so adjusting for a time lag is unnecessary. This is why the software uses the **Center Location** value to position the sample for AC measurements.

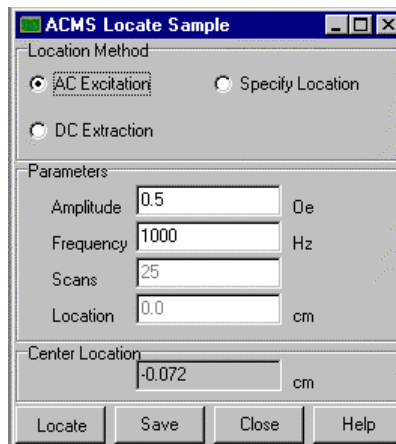

Figure 4-1. **Locate Sample** Dialog Box with **AC Excitation** Option Selected

The DC centering method is similar to a DC moment measurement. When the **DC Extraction** option is selected, a DC field can be applied to the measurement region and the sample is moved rapidly through the detection coil set. The changing flux through the detection coils induces a signal in the coils. During immediate-mode operations, the integrated signal is displayed in the **Waveforms** tab in the ACMS control center. When performing DC centering, the ACMS software uses this integrated signal to calculate the sample's center position (using the same algorithm used in the AC centering method) instead of calculating the sample moment. This position is reported in the **Location** panel in the **Locate Sample** dialog box. However, this is not the actual sample center position because electronics cause a short *time* delay between the coil response and the reported sample position. This translates into an apparent response curve *position* offset. The sample speed is a known constant,

so an apparent offset value can be determined. The constant offset value, which is specific to each ACMS system, is determined and set at the factory. The so-called DC-AC position offset is added to the **Location** value in order to obtain the **Center Location** value.

During AC sample centering (section 4.3.2), 64 points record the real component and 64 points record the imaginary component of the signal for each of 64 sample positions. The amplitude of each signal is used to create a flux profile for the detection coils as a function of sample position. The sample's center position is calculated from this curve.

4.3.2 Centering the Sample with the AC Excitation Method

4.3.2.1 CENTERING THE SAMPLE IN IMMEDIATE MODE

To run AC centering in immediate mode, you select a data file and install the sample as you would for any sample measurement. (See steps 1 through 3 in section 4.4.1.1, for example.) You then select either the **Locate Sample** button in the ACMS control center *or* the **Measure**►**Locate Sample** menu option in order to open the **Locate Sample** dialog box (figure 4-1). In the dialog box, you select the **AC Excitation** option, and then you define the amplitude and frequency. All other text box fields in the dialog box are disabled.



NOTE

If measurements will be performed using very low or very high frequency fields or low or high amplitude fields, it is recommended that you center the sample by using similar frequency and amplitude values.

Selecting **Locate** in the **Locate Sample** dialog box begins the centering operation. The sample moves through the entire length of the detection coil set. When centering is complete, you examine the results of the centering scan.

- The **Center Location**, as indicated in the **Locate Sample** dialog box, should be between -0.4 and $+0.4$. If it is not, you should either center the sample manually or remove it and physically center it.
- The AC response curve appearing in the **Waveforms** tab in the ACMS control center should be antisymmetric with a vertical line through the center of the curve and equal areas under each half of the curve. Refer to figure 4-2. If the vertical line appears slightly off center, running AC centering again can help attain an even better center.

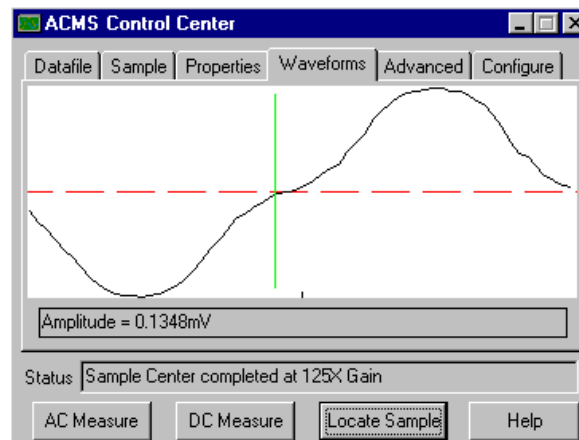

Figure 4-2. Example of Plot of AC Centering in **Waveforms** Tab

If the response curve is shifted considerably or is distorted, you may need to remove the sample from the sample chamber and remount it so that it lies closer to the center of the detection coil set, or you may need to mount the sample more securely in order to prevent it from shifting during the measurement. Because the centering operation begins with the sample at the bottom of the range of motion, apparent curve offsets to the right usually indicate the sample is mounted too low and should be moved

- The **Center Location**, as indicated in the **Locate Sample** dialog box, should be between -0.4 and $+0.4$. If it is not, you should center the sample manually.
- The DC response curve appearing in the **Waveforms** tab in the ACMS control center should display symmetry, with equal areas under the two lobes. Refer to figure 4-4. The response curve should either match the reference waveform or display a negative image of the reference waveform. If it does not, the centering procedure was unsuccessful and should be run again. If this still does not help, the sample probably needs to be secured within the sample holder or remounted so that it lies closer to the center of the detection coils.

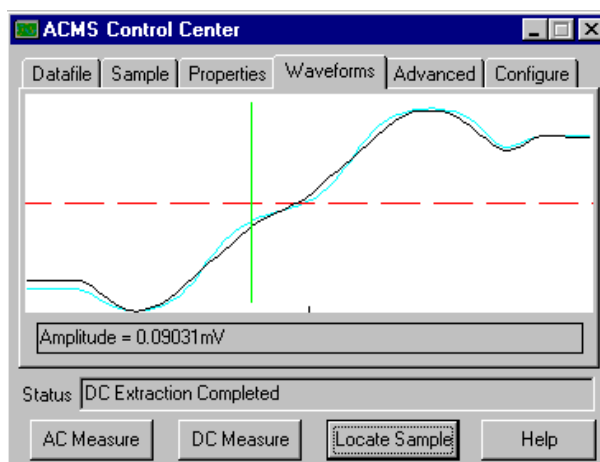

Figure 4-4. Example of Plot of DC Centering in **Waveforms** Tab

You must select the **Save** button in the **Locate Sample** dialog box if you want to save the centering results to the specified data file or files.

4.3.3.2 CENTERING THE SAMPLE IN SEQUENCE MODE

To run DC centering in sequence mode, you add the **Locate Sample** sequence command, with **DC Extraction** as the selected centering method, to any sequence file, and then you run the sequence.

The **Locate Sample** sequence command is in the **Measurement Commands** group in the sequence command bar. Selecting **Locate Sample** opens the **Locate Sample** dialog box. In the dialog box, you select the **DC Extraction** option and specify the number of scans just as you would for an immediate-mode DC centering operation. Selecting **OK** in the **Locate Sample** dialog box adds the **Locate Sample** command to the sequence. You then select a data file, install the sample, and run the sequence as you would for any sequence-mode measurement. (See steps 5 through 7 in section 4.4.2.2, for example.)

4.3.4 Specifying the Sample Location

You can specify the location of the sample if the software has incorrectly calculated the sample location and you know the sample's actual location. Simply open the immediate-mode or sequence mode **Locate Sample** dialog box (see section 4.3.3.1 or 4.3.3.2, for example), and then select the **Specify Location** option. In the **Location** text box field, enter the actual location of the sample, and select **Locate**.

4.3.5 Moving the Sample

Independent from any measurements you might take, you may move the sample to a specific location within the detection coils. The ACMS software supports independent sample movement in immediate mode and sequence mode.

Commands for independent sample movement in immediate mode are in the **Advanced** tab in the ACMS control center. To move the sample immediately, you enter the location in the **Move to** text box that is in the **Transport** section, and then you select the **Move to** button.

You select the **Test** button in the **Advanced** tab to move the ACMS sample transport through the full range of its movement and verify that it moves.

To move the sample within a sequence, you add the **Locate Sample** sequence command, with **Move Sample** as the selected locating method, to any sequence file, and then you run the sequence. The **Locate Sample** sequence command is in the **Measurement Commands** group in the sequence command bar. In the **Locate Sample** dialog box, you select the **Move Sample** option. Then in the **Location** text box field, you enter the location to which you want the sample to move.

4.4 Taking ACMS Measurements



NOTE

ACMS measurements can be taken only if the ACMS hardware is installed and the ACMS option is activated in the PPMS MultiVu software. Refer to chapter 2 to install and activate the ACMS option.



NOTE

A sample should be centered relative to the detection coils in the ACMS insert before it is measured for the first time. A sample should be re-centered following any large temperature change, and it is advisable to re-center the sample prior to re-measuring it with a different measurement method. Refer to section 4.3 to center the sample.

Before you take measurements, you may want to refer to section 4.2.3, “Choosing a Measurement Method,” and section 4.2.4, “Operating Modes.”

4.4.1 Taking AC Susceptibility Measurements

4.4.1.1 TAKING A MEASUREMENT IN IMMEDIATE MODE

To summarize, you take a measurement in immediate mode by first installing the sample and then defining and running the measurement. Complete the following steps:

1. Select the **Datafile** tab in the ACMS control center if you want to select a different data file or create a new file (see section 6.4.1). The **Properties** tab in the control center displays the sample property information stored in the header of the selected data file. If you run the measurement when no data file is selected, the data is discarded.
2. Mount the sample on a suitable sample holder. Refer to section 3.2.
3. Select the **Sample** tab in the ACMS control center. Then select the **Change** button and insert the sample into the sample chamber. Section 3.3 describes this procedure.
4. Select the **AC Measure** button in the ACMS control center *or* select the **Measure** > **AC Magnetization** menu option. The **AC Magnetization** dialog box opens.

Figure 4-5. **AC Magnetization** dialog box. Items on the left side of the dialog box designate measurement conditions that should be set prior to initiating the measurement. Items on the right side of the dialog box display the results of the last immediate-mode AC measurement.

5. Define the AC measurement as follows.
 - a. Define the **Amplitude** of the sine wave excitation that is applied to the sample. Not all amplitude values can be achieved in all frequency and temperature ranges. Amplitudes up to 10 Oe are producible at all frequencies and temperatures.
 - b. Define the **Frequency** of the sample excitation signal.
 - c. Define either the measurement's **Duration** or **Count**. Notice that changing the **Duration** affects the value of the **Count** parameter, and changing the **Count** affects the value of the **Duration** parameter. Changing the **Frequency** also affects the **Duration** parameter.
 - d. Select the **Ranging** mode used for voltage detection. **Autorange** changes the gain setting at the beginning of every measurement so that the optimum setting is selected. **Sticky Autorange** prevents the gain from changing until it is absolutely necessary. **Fixed Range** uses only a single user-specified gain setting.
 - e. Select the **Measure Mode** that defines the number and location of the individual measurements that are taken and averaged to obtain a single, final measurement value. Five measure modes are available for immediate-mode AC measurements. The default and most comprehensive measure mode is the five-point measurement. The fastest and least comprehensive mode is the one-point measurement. Refer to table 4-1.

Table 4-1. Measure Modes for AC Susceptibility Measurements

MEASUREMENT MODE	WHERE MEASUREMENTS ARE TAKEN	SUGGESTED USE
Five Point	(1) Bottom detection coil (2) Top detection coil (3) Bottom detection coil (4) Center of coil array (5) Center of coil array	Use for most accurate phase and calibration information. Use if temperature is unstable or if temperature will change during measurement. Bottom-top-bottom measurement cancels effect of temperature drift.
Four Point	(1) Bottom detection coil (2) Top detection coil (3) Center of coil array (4) Center of coil array	Use for accurate phase and calibration information if temperature is stable and will not change during measurement.
Three Point	(1) Bottom detection coil (2) Top detection coil (3) Bottom detection coil	Use for faster, but less accurate, measurements. Three-point measurement uses calibration from previous four- or five-point measurement. <i>You must have run a four- or five-point measurement prior to running a three-point measurement.</i>
Two Point	(1) Bottom detection coil (2) Top detection coil	Use for faster, but less accurate, measurements. Two-point measurement uses calibration from previous four- or five-point measurement. <i>You must have run a four- or five-point measurement prior to running a two-point measurement.</i>
One Point	(1) Bottom detection coil	Use for fastest, but least accurate, measurements. One-point measurement uses calibration from previous four- or five-point measurement. <i>You must have run a four- or five-point measurement prior to running a one-point measurement.</i>

6. Select the **Measure** button in the **AC Magnetization** dialog box. The measurement begins. You may want to open the **Waveforms** tab in the ACMS control center so that you can see the plots produced for the individual measurements.
7. Examine the final diagnostic plot of the measurement in the **Waveforms** tab. The plot shows you whether the sample was read and roughly indicates how effective the measurement was.

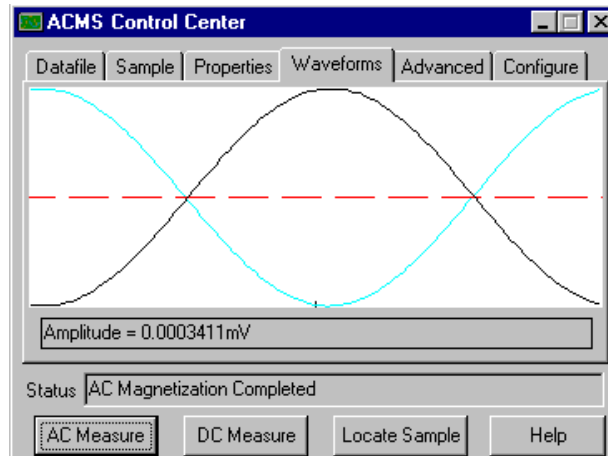

Figure 4-6. Example of plot of AC measurement in **Waveforms** tab. The light blue line that may appear in the tab is the waveform reference and indicates the ideal measurement results. You use the waveform reference to help determine the effectiveness of the measurement. The waveform reference is not visible if the measured waveform and ideal plot are nearly identical.

8. Select the **Save** button if you want to save the measurement results to the specified data file or files. You must select **Save** in order to save the data.

4.4.1.2 TAKING A MEASUREMENT IN SEQUENCE MODE

To take a measurement in sequence mode, you first define the sequence file and include the measurement command in the sequence file. Then after you install the sample, you run the sequence, and the measurement is executed when the measurement command is read in the running sequence. A single sequence file may include any number of measurement sequence commands.

The **AC Magnetization** measurement sequence command can either take a single AC measurement—just like the immediate-mode AC measurement—or it can function like a scan sequence command and take multiple measurements within a control loop. **AC Magnetization** functions like a scan command if you define an amplitude or frequency range for the command parameters. Refer to the *Physical Property Measurement System: PPMS MultiVu Application User's Manual* for detailed information about scan commands and control loop operation.

Complete the following steps to take an AC measurement in sequence mode:

1. Select a new or existing sequence file.
2. Select the **AC Magnetization** command, which is in the **Measurement Commands** group in the sequence command bar. Then select the **Measure** tab in the **AC Magnetization** dialog box. See figure 4-7 on the following page.

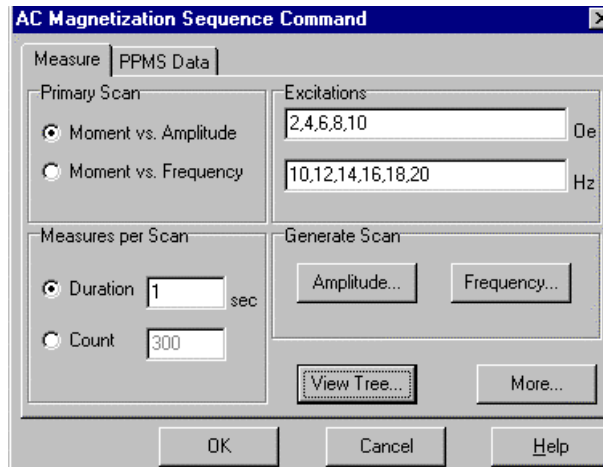

Figure 4-7. Measure Tab in AC Magnetization Sequence Command Dialog Box

- a. Specify the primary scan mode for the measurement. The scan mode determines whether the amplitude or frequency is measured first. The measurement order may be important if you are using the **AC Magnetization** command like a scan command.
- b. Define either the measurement's **Duration** or **Count**.
- c. Define the **Amplitude** of the sine wave excitation that is applied to the sample. Do one of the following:
 - Enter a single value in the **Amplitude** text box.
 - Select the **Amplitude** button and define an amplitude range in the **Scan AC Field** dialog box. Defining a range prompts the **AC Magnetization** command to function like a scan command. Do the following: specify the initial and final set points, select a spacing mode (see table 4-2), specify the increment between the set points (if applicable), and specify the number of set points.

Table 4-2. Amplitude Spacing Modes

SPACING MODE	DEFINITION
Uniform	Uniform spacing equally spaces the set points. This mode allows you to define the increment separating the set points. Uniform spacing is the default spacing mode.
log(H)	log(H) spacing logarithmically spaces the set points, so defining the increment separating the set points is unnecessary.
H ²	H ² spacing equally spaces the set points in the square of the field, so defining the increment separating the set points is unnecessary.

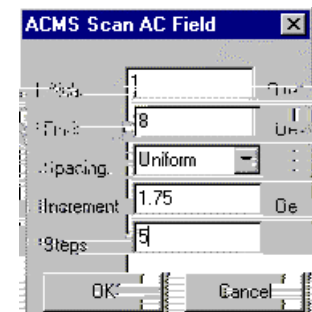

Figure 4-8. Scan AC Field Dialog Box



NOTE

Not all amplitude values can be achieved in all frequency and temperature ranges. Amplitudes up to 10 Oe are producible at all frequencies and temperatures.

- d. Define the **Frequency** of the sample excitation signal. Do one of the following:
- Enter a single value in the **Frequency** text box.
 - Select the **Frequency** button and define a frequency range in the **Scan Frequency** dialog box. Defining a range prompts the command to function like a scan command. Do the following: specify the initial and final set points, select a spacing mode (see table 4-3), specify the increment between the set points (if applicable), and specify the number of set points.

Table 4-3. Frequency Spacing Modes

SPACING MODE	DEFINITION
Uniform	Uniform spacing equally spaces the set points. This mode allows you to define the increment separating the set points. Uniform spacing is the default spacing mode.
log(f)	log(f) spacing logarithmically spaces the set points, so defining the increment separating the set points is unnecessary.
1/f	1/f spacing uses the inverse frequency to equally space the set points, so defining the increment separating the set points is unnecessary.

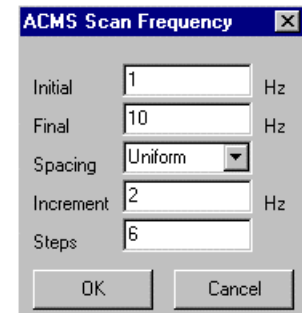

Figure 4-9. Scan Frequency Dialog Box

- e. Select the **View Tree** button if you want to see a visual representation of the control loop measurement that is defined by the amplitude and frequency ranges. For example, the view tree in figure 4-10 depicts a control loop for a **Moment vs. Amplitude** primary scan mode (see figure 4-7) measurement. Measurements are taken at multiple frequencies while the system holds a single amplitude.

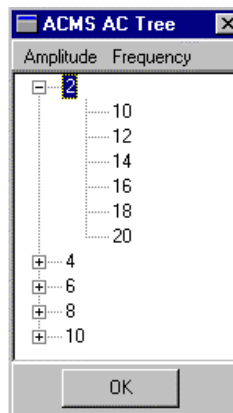

Figure 4-10. ACMS View Tree

- f. Select the **More** button in the **Measure** tab if you want to choose the **Ranging** mode used for voltage detection. **Autorange** changes the gain setting at the beginning of every measurement so that the optimum setting is selected. **Sticky Autorange** prevents the gain from changing until it is absolutely necessary. **Fixed Range** uses only a single user-specified gain setting.

Table 4-4. Maximum AC Field Amplitude (Oe) to Avoid Warming

Measurement Time (sec)	Temperature (K)	Frequency (Hz)			
		10	100	1,000	10,000
0.1	1.9	10	10	10	3.5
	4	17	17	17	6
	10	17	17	17	17
	20	17	17	17	17
	25	17	17	17	17

property information stored in the header of the selected data file. If you run the measurement when no data file is selected, the data is discarded.

2. Mount the sample on a suitable sample holder. Refer to section 3.2.
3. Select the **Sample** tab in the ACMS control center. Then select the **Change** button and insert the sample into the sample chamber. Section 3.3 describes this procedure.
4. Select the **DC Measure** button in the ACMS control center *or* select the **Measure**►**DC Extraction** menu option. The **DC Magnetization** dialog box opens.

Figure 4-12. **DC Magnetization** dialog box. Items on the left side of the dialog box designate measurement conditions that should be set prior to initiating the measurement. Items on the right side of the dialog box display the results of the last immediate-mode DC measurement.

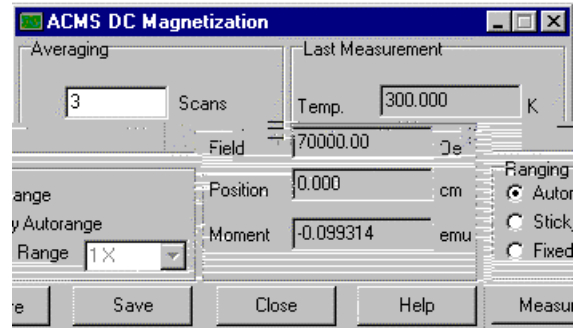

5. Define the DC measurement as follows.
 - a. Define the number of **Scans** that are taken and averaged to obtain a measurement value.
 - b. Select the **Ranging** mode used for voltage detection. **Autorange** changes the gain setting at the beginning of every measurement so that the optimum setting is selected. **Sticky Autorange** prevents the gain from changing until it is absolutely necessary. **Fixed Range** uses only a single user-specified gain setting.
6. Select the **Measure** button in the **DC Magnetization** dialog box. The measurement begins.
7. Examine the diagnostic plot of the measurement in the **Waveforms** tab. The plot shows you whether the sample was read and roughly indicates how effective the measurement was.

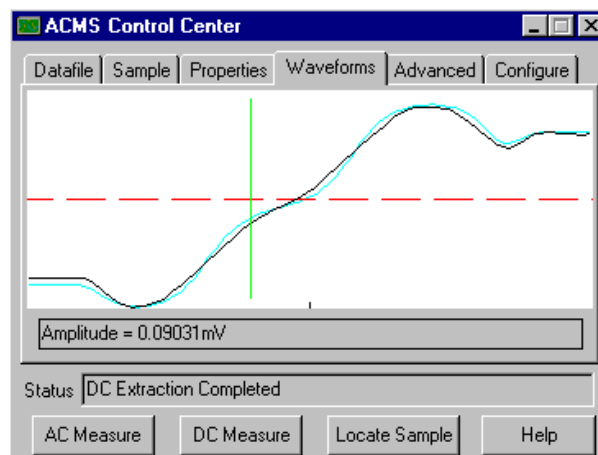

Figure 4-13. Example of plot of DC measurement in **Waveforms** tab. The light blue line that may appear in the tab is the waveform reference and indicates the ideal measurement results. You use the waveform reference to help determine the effectiveness of the measurement. The waveform reference is not visible if the measured waveform and ideal plot are nearly identical.

8. Select the **Save** button if you want to save the measurement results to the specified data file or files. You must select **Save** in order to save the data.

4.4.2.2 TAKING A MEASUREMENT IN SEQUENCE MODE

To take a measurement in sequence mode, you first define the sequence file and include the measurement command in the sequence file. Then after you install the sample, you run the sequence, and the measurement is executed when the measurement command is read in the running sequence. A single sequence file may include any number of measurement sequence commands.

Complete the following steps to take a DC measurement in sequence mode:

1. Select a new or existing sequence file.
2. Select the **DC Extraction** command, which is in the **Measurement Commands** group in the sequence command bar. Then select the **Measure** tab in the **DC Magnetization** dialog box, and define the DC measurement as follows.
 - a. Define the number of **Scans** that are taken and averaged to obtain a measurement value.
 - b. Select the **Ranging** mode used for voltage detection. **Autorange** changes the gain setting at the beginning of every measurement so that the optimum setting is selected. **Sticky** **Autorange** prevents the gain from changing until it is absolutely necessary. **Fixed Range** uses only a single user-specified gain setting.

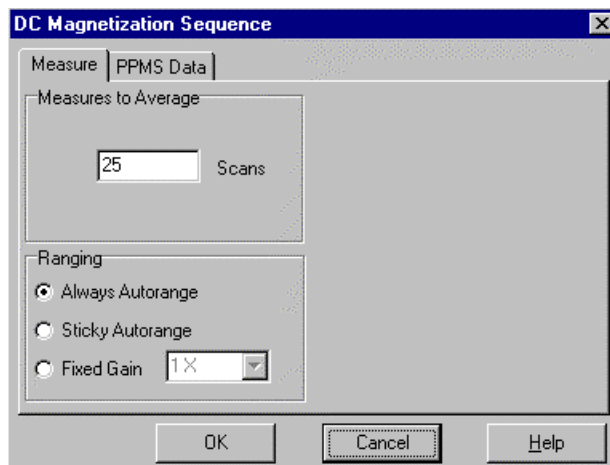

Figure 4-14. **Measure** Tab in **DC Magnetization Sequence Command** Dialog Box

3. Select the **PPMS Data** tab in the **DC Magnetization** dialog box, and then select the data items you want to save to the measurement data file. By default, the general system status, system temperature, magnetic field, and the reading from mappable channel 25 (the sample temperature) are saved to the file.
4. Select the **OK** button in the **DC Magnetization** dialog box to add the **DC Extraction** command to the sequence.
5. Save the sequence.
6. Select a data file and install the sample just as you would for any immediate-mode measurement. See steps 1 through 3 in section 4.4.2.1.

During the sequence run, you may also prompt the ACMS software to save the sequence measurement data to different data files. Refer to section 6.4.3. Remember to save the sequence again if you make any additional changes to it.

7. Select any **Run Sequence** command in PPMS MultiVu. Then wait for the sequence run to finish. The commands in the sequence determine the length of time the sequence runs. When the run is complete, all **Run** commands are enabled. The measurement data is automatically saved to the data file you previously selected.

Hardware

5.1 Introduction

This chapter contains the following information:

- Section 5.2 lists the main ACMS hardware components.
- Section 5.3 discusses and illustrates the ACMS hardware components.

5.2 Overview of Hardware

ACMS system components include the following:

- | | |
|---|---|
| <input checked="" type="checkbox"/> ACMS insert | <input checked="" type="checkbox"/> Sample transport/servo controller cable |
| <input checked="" type="checkbox"/> ACMS sample transport | <input checked="" type="checkbox"/> Model 6000/servo controller cable |
| <input checked="" type="checkbox"/> ACMS sample holder | <input checked="" type="checkbox"/> ACMS preamp cable |
| <input checked="" type="checkbox"/> AC board | <input checked="" type="checkbox"/> Palladium calibration sample |
| <input checked="" type="checkbox"/> Servo controller | <input checked="" type="checkbox"/> 4-40 thumbscrew |

Chapter 2 explains how to install the ACMS insert, ACMS sample transport, and ACMS cables.

The Palladium sample shipped with the ACMS is used to calibrate the ACMS according to Quantum Design service note 1084-302. Quantum Design calibrates each system prior to shipment. However, some customers may require re-calibration in the future. Re-calibration should be performed only by qualified personnel. Note that the Palladium sample should be kept clean.

Figure 5-1. ACMS Insert

5.3.2 ACMS Sample Transport

The ACMS sample transport is the device moving the installed sample. After the ACMS insert is installed in the PPMS, the ACMS sample transport is mounted directly on top of the PPMS sample chamber opening.

The top of the ACMS sample transport has a sample chamber access port through which the ACMS sample holder assembly is inserted. The electrical connector on the rear of the transport is used to connect the ACMS sample transport to the servo controller box.

Several software commands can control the movement of the servo motor in the ACMS sample transport. The **Locate Sample**►**Move Sample** sequence command moves the servo motor and thus the sample within a sequence. Any of the **Transport** commands in the **Advanced** tab in the ACMS control center (see section 6.2.1.5) affect transport operation immediately:

- **Move to** moves the transport to a specific location.
- **Test** moves the transport through the full range of its movement and verifies movement.
- **Disconnect** disconnects the transport from the software.
- **Reconnect** reconnects the transport to the software.

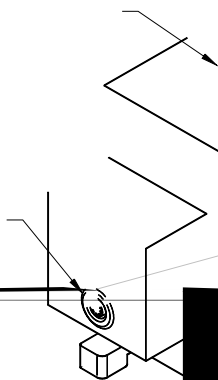

A buildup of residue inside the assembly may cause the transport to stick. The system fails when the transport resistance exceeds a value that the servo controller assembly can easily drive, and you will see the error message, “Sample Transport is Blocked.” At this point, make sure the assembly is at room temperature and the sample is not installed. If the sample transport is still blocked, clean the sample transport assembly.

Note: Do not use solvents or lubricants to clean the assembly or the block. Also, make sure that the small breaker switch on the rear of the ACMS Servo Controller/Magnet Tray is set. If this breaker is not tripped, it will be very hard to switch. If it has been tripped, it will be easy to reset.

1. Remove the sample transport assembly from the PPMS probe head.
2. From the top of the block positioner, insert a pen-sized instrument (one that won't scratch any surface of the assembly) into the cylinder. Push the slider tube and gear rack assembly down to the base of the block positioner.
3. Turn the block positioner over and remove the circlip from the bottom of the cylinder. The circlip is the small c-shaped wire that holds the slider tube and gear rack assembly in the block positioner. Removing the circlip allows you to remove the slider tube and gear rack assembly.
4. Use tweezers to rotate the circlip around until it is exposed at the notch. Once the circlip is exposed, use the tweezers to remove it from the cylinder. Be careful not to lose the circlip.
5. Remove the slider tube and gear rack assembly from the cylinder by pushing it down with the pen-sized instrument from the top of the block positioner.
6. Clean the gears and the inner and outer surfaces of the slider tube and gear rack assembly with a dry cotton swab. Next, clean the inside of the block positioner's cylinder with a cotton swab.
7. After everything is clean, replace the slider tube and gear rack assembly. Insert it, beveled end first, into the cylinder from the bottom of the block positioner and push it up.
8. Replace the circlip. Make sure no part of it is exposed at the notch. Next, replace the sample transport assembly on the PPMS probe head.

5.3.2.1.3 Cleaning the o-rings

Periodically clean the o-rings on the bottom of the ACMS sample transport and under the transport cap. If you still see pressure control problems, inspect the o-rings and replace them with new ones if necessary.

1. Clean with a soft, lint-free cloth.
2. Lightly lubricate with silicone vacuum grease.

5.3.3 ACMS Sample Holder Assembly

The sample holder assembly is specifically designed to be used with the ACMS. After the ACMS insert and ACMS sample transport are installed in the PPMS, the sample holder assembly is inserted into the ACMS insert through the access port located on top of the ACMS sample transport.

The sample holder assembly consists of three main components: the long sample rod, short sample rod, and bucket. These components are constructed of light-weight Delrin to ensure smooth sample transport. The sample rods are suitable for bulk or powdered samples, but are not recommended for liquid samples.

BLACK END-CAP

79.8 cm (approx.)

Ultrasonic cleaner and mild

Sample holder should periodically be cleaned with a soft, fine-grit abrasive vacuum grease. The frequency of this procedure depends on the sample. If you observe pressure control problems, inspect the

4 AC Board

Clean the rod with an u

PART

5.3.3.1 MAINTENANCE

To prevent residue from ruining later measurements, you should thoroughly clean sample holder rods after they have been used with powdered samples.

The AC board houses the electronics that excite the AC drive coils and measure the response signal in the ACMS detection coils. When PPMS systems are shipped with the ACMS option, the AC board

is installed in the Model 6000 PPMS Controller prior to delivery. The AC board is accessible by the “P3–Option” port on the rear panel of the Model 6000.

A board identical to the AC board is used for the PPMS AC Transport (ACT) option. The AC board is specially calibrated for use with each set of hardware.

5.3.5 Servo Controller

The ACMS servo controller provides current to the ACMS servo motor and should be connected to the ACMS sample transport. When PPMS systems are shipped with the ACMS option, the servo controller is installed behind the PPMS magnet controller console, which is in the electronics cabinet, prior to delivery.

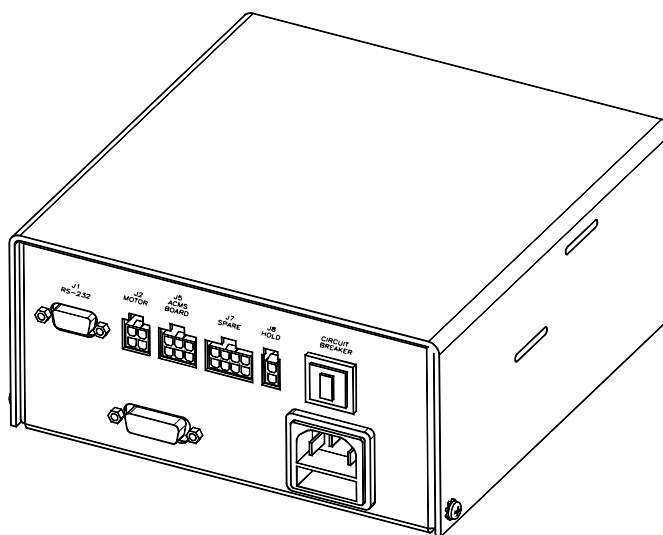

5.3.6 Sample Transport/Servo Controller Cable

The sample transport/servo controller cable (part number 3084-290) is the connecting cable for the ACMS option. The cable plugs into the port on the rear panel of the ACMS sample transport and into the “J2 Motor” and “J9 Encoder” ports on the ACMS servo controller. Refer to figure 2-3, “ACMS Connections.”

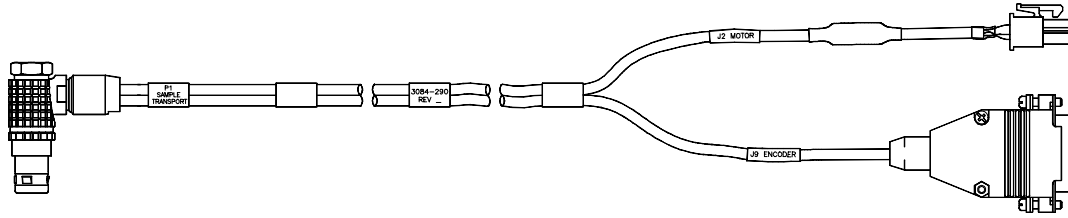

Figure 5-5. Sample Transport/Servo Controller Cable

5.3.7 Model 6000/Servo Controller Cable

The Model 6000/servo controller cable (part number 3084-289) connects the ACMS board that is inside the Model 6000 PPMS Controller to the ACMS servo controller. The cable plugs into the “P3–Option” port on the Model 6000 and into the “J5 ACMS Board” port on the servo controller. Refer to figure 2-3, “ACMS Connections.”

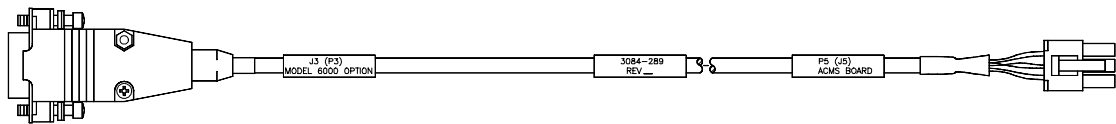
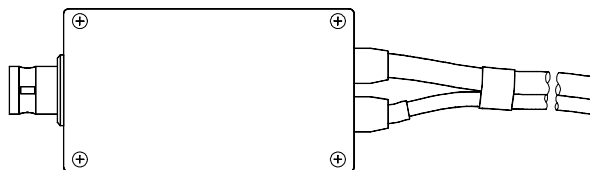

Figure 5-6. Model 6000/Servo Controller Cable

5.3.8 Preamp Cable

The ACMS preamp cable assembly (part number 4084-050) amplifies the signals from the detection coils in the ACMS coil set.

The preamp box plugs into the gray, color-coded port on the PPMS probe head. The two cables that are attached to the preamp box plug into the “P2–System Bridge” and “P3–Option” ports on the Model 6000 PPMS Controller. Refer to figure 2-3, “ACMS Connections.”



Software

6.1 Introduction

This chapter contains the following information:

- Section 6.2 presents an overview of the ACMS software and discusses the ACMS control center.
- Section 6.3 discusses the ACMS status log.
- Section 6.4 discusses and explains how to create ACMS data files.

6.2 Overview of the ACMS Software

The ACMS software is integrated into the Windows-based PPMS MultiVu application, so ACMS operation may benefit from the full functionality of PPMS MultiVu, and PPMS MultiVu commands may be used to automate ACMS measurements. For example, within the same PPMS MultiVu sequence file, the ACMS system can take multiple temperature-dependent susceptibility sequences at different fields followed by several DC magnetization measurements at different temperatures. No user intervention is required to perform complex measurements within a single PPMS MultiVu sequence.

DC magnetization measurements and AC susceptibility measurements performed by the ACMS system are defined by user-specified measurement parameters. Measurement results and other relevant parameters reported by the Model 6000 PPMS Controller are stored in ACMS measurement data files.

6.2.1 ACMS Control Center

The ACMS software has a control center that includes all frequently selected ACMS commands. With its easy-to-use tab format and software prompts, the ACMS control center makes basic system operations, such as creating data files, installing samples, and setting up and running immediate-mode measurements, more natural and convenient. The ACMS control center opens as soon as the ACMS option is activated, and although it may be minimized, does not close until the option is deactivated. Figures 6-1 through 6-5 illustrate tabs in the ACMS control center.

The **Status** bar at the bottom of the ACMS control center summarizes the general status of the ACMS system. The **Status** bar indicates the progress of an on-going measurement and summarizes the results of the last measurement. Color-coded warning and error messages in the **Status** bar alert you to possible problems. Warning messages appear on a yellow background. Error messages appear on a red background. Appendix A lists the warning and error messages.

6.2.1.1 DATAFILE TAB

The **Datafile** tab identifies which data file or files will save measurement data, and it indicates the highest harmonic that will be saved to the selected data files. If no measurement data file has been selected, the **Path**, **Name**, and **Title** panels in the **Datafile** tab are blank. Sample measurement data is saved only if a measurement data file is selected. Raw voltage data is saved only if a measurement data file is selected *and* the **Log Raw Data** check box is enabled. Measurements may run when a measurement data file is not selected, but the measurement data is discarded.



NOTE

Saving raw voltage data is an option but can be useful under certain conditions. Be aware that raw data files are very large because each individual data point is stored as an entire record and no data reduction is performed. Raw data is saved to a separate raw data file that has the identical base name as the measurement data file, but a `.raw` file extension instead of a `.dat` extension.

The **View** button in the **Datafile** tab opens the graph view of the selected measurement data file. You can use the **Comment** button to append a comment to the measurement data file (see section 6.4.2). The comment may be a string of unlimited length.

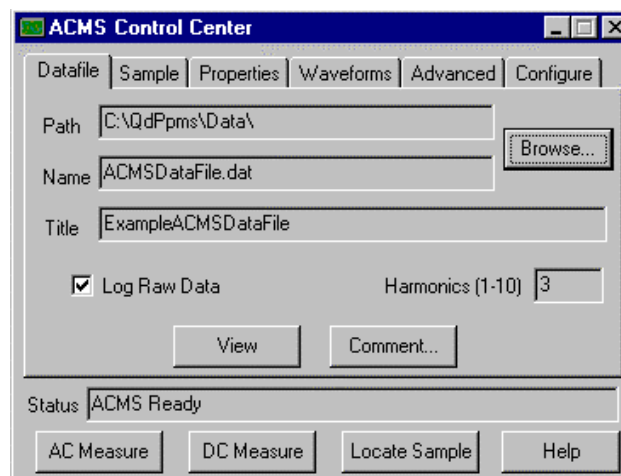

Figure 6-1. **Datafile** Tab in ACMS Control Center

You can use the **Datafile** tab to select or create a data file. The **Browse** button in the tab opens the **ACMS Select Existing or New Data File** dialog box, which lists all existing files and lets you create a new measurement data file. When you create a new file, the software prompts you to specify (1) the data file title, which appears above the plot of the graph view of the file; (2) the highest harmonic that will be recorded to the file; and (3) the sample properties. Because the sample property information is stored in the data file header, it can only be specified when the data file is created and cannot be subsequently changed. Section 6.4.1 explains in detail how you create an ACMS data file.

6.2.1.2 SAMPLE TAB

The **Sample** tab is used to initiate insertion of a sample into or removal of a sample from the PPMS sample chamber. The **Sample** tab also indicates the installed sample's location relative to the center of the detection coils in the ACMS coil set. The **Sample Status** panel at the top of the tab always identifies the current status of the sample chamber.

The **Change/Finished** toggle button in the **Sample** tab initiates and concludes the sample insertion or removal process. When you select **Change**, the sample holder assembly is raised and vacuum is lost, so you may remove the sample. Selecting **Finished** after the sample is removed reestablishes vacuum in the sample chamber. You must select **Finished** prior to starting any measurements. You may use the **Disable Vent/Purge** check box that is at the bottom of the **Sample** tab in order to prevent the state of the system vacuum from changing automatically.



CAUTION

The system should always be at room temperature (298 K) before you attempt to insert or remove a sample, otherwise ice formation and cryopumping of air constituents can cause serious problems with the system.

If the sample insertion or removal process is not completed within 90 seconds, the servo motor is turned off to prevent it from overheating. When the servo motor is turned off, the **Motor On** button in the **Sample** tab is enabled. Select **Motor On** to turn the servo motor back on and complete the sample insertion or removal. Notice that you must still select **Finished** after you select **Motor On**.

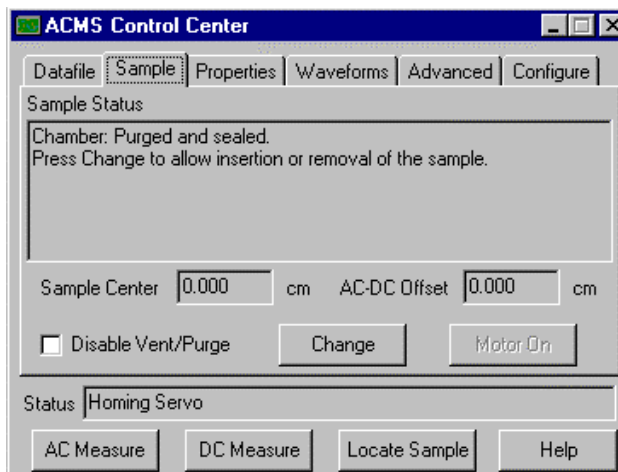

Figure 6-2. **Sample** Tab in ACMS Control Center

The **Sample Center** panel in the **Sample** tab indicates where the sample is located relative to the detection coils in the ACMS coil set. The **AC-DC Offset** panel indicates the sample's center location as determined by the AC centering or DC centering operation. A large offset indicates that the AC center and/or the DC center measurements had large errors.

6.2.1.3 PROPERTIES TAB

The **Properties** tab lists the sample property information stored in the header of the measurement data file that is identified in the **Datafile** tab. The sample property information was defined when the data file was created and may not be subsequently changed.

There are no fixed sample properties. The ACMS software does not use the sample properties to determine any data.

6.2.1.4 WAVEFORMS TAB

The **Waveforms** tab shows a diagnostic plot of the last measurement or centering operation. The actual measured waveform is shown in black. The light blue curve in the display area is the waveform reference, which indicates the ideal measurement results obtained by measuring a sample that is a known calibration standard. The waveform reference line is not visible if the measured waveform and ideal plot are nearly identical.

The plot in the **Waveforms** tab is overwritten each time another measurement runs.

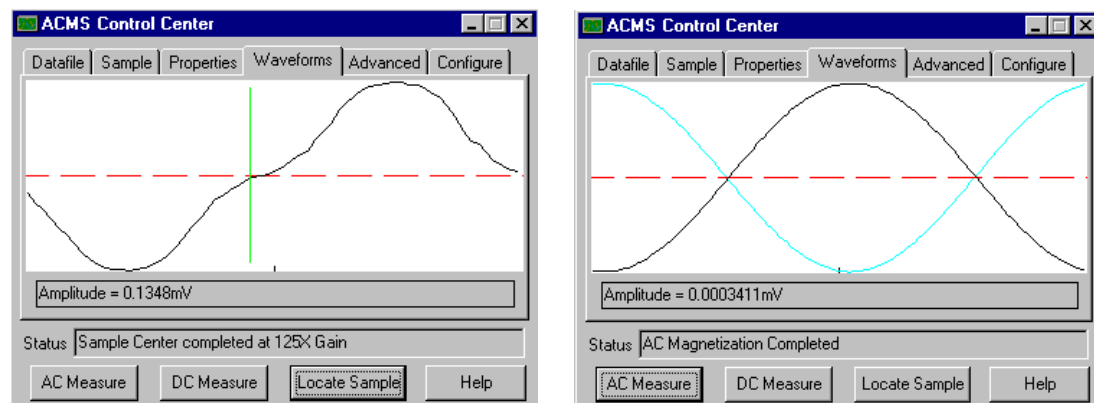

Plot of AC Centering Scan

Plot of AC Measurement

Figure 6-3. **Waveforms** Tab in ACMS Control Center

6.2.1.5 ADVANCED TAB

The **Advanced** tab contains commands that should be used by only experienced ACMS operators. The **Transport** commands in the **Advanced** tab allow the ACMS sample transport to be moved manually or to be disconnected or reconnected to the ACMS software. The **Recalibration** commands create new calibration files for AC and DC measurements.

The **Move to** command moves the ACMS sample transport to a specific location. (See section 4.3.5 for more information on moving the sample transport.) The **Test** command moves the ACMS sample transport through the full range of the transport's movement and verifies that it moves. **Disconnect** disconnects the ACMS sample transport from the ACMS software. **Reconnect** reconnects the transport to the software.

The **Recalibration** commands, which are generally used only with a known sample, create new calibration files that are used for all subsequent AC and DC measurements. The **Waveform** command stores the last DC measurement as a calibration standard. The **AC Scale** command stores the last AC measurement as a calibration standard.

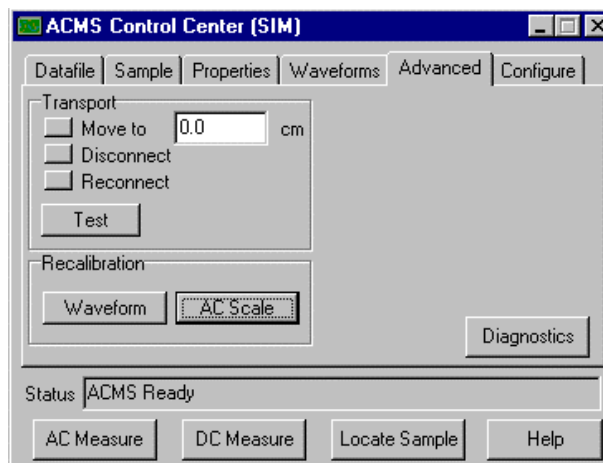

Figure 6-4. **Advanced** Tab in ACMS Control Center

The diagnostic mode accessed through the **Diagnostics** button in the **Advanced** tab is password protected and is used only by service personnel.

6.2.1.6 CONFIGURE TAB

The **Configure** tab sets several ACMS system settings. You can use the tab to instruct the system to test the DSP or the ACMS sample transport whenever the ACMS option is activated in the PPMS MultiVu software, and you can select the AC excitation mode or the detection technique. The ACMS sample transport is tested by being moved through its full range of motion.

Two AC excitation modes are available. **Burst**, which is the default mode, activates the drive coils only during the measurement step. **Continuous** keeps the drive coils activated during the entire measurement process.

The detection technique selection alters the signal analysis routine. **Correlating**, which is the default mode, uses a sine wave to calculate the sample moment and is preferable under normal measurement circumstances. **Integrating** uses a square wave.

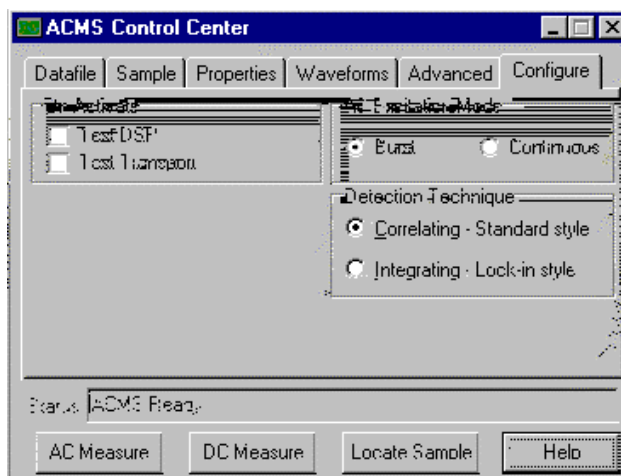

Figure 6-5. **Configure** Tab in ACMS Control Center

6.2.1.7 MEASUREMENT COMMAND BUTTONS

The **AC Measure**, **DC Measure**, and **Locate Sample** command buttons in the ACMS control center define and run immediate-mode AC measurements, DC measurements, and centering measurements, respectively. Chapter 4 explains how you use the control center command buttons to run measurements in immediate mode.

6.3 ACMS Status Log

The ACMS status log records high-level hardware and software activity during ACMS measurements, and during system hardware checks, it records the test results. The ACMS status log also captures warnings, errors, and informational messages that were generated since the ACMS option was last activated in the PPMS MultiVu software. The status log displays the results of only the active ACMS session, although it keeps a record of all ACMS sessions in the log file. The ACMS status log captures more types of information than the PPMS MultiVu event log. The **View►ACMS Status Log** command activates the status log. The name of the default status log file is `AcmsLog`.

You use the ACMS status log to review a finished measurement or hardware test and to search for any problems that might have occurred. Because the status log records important measurement information, you may be absent when a sequence file runs; you simply review the status log after the sequence run is finished.



Figure 6-6. ACMS Status Log

6.4 ACMS Data Files

The ACMS software creates measurement data files and raw measurement data files and stores ACMS measurement data in these files. Measurement data files, which have a `.dat` file extension, store sample measurement data for any number of measurements taken by either or both of the two measurement types supported by the ACMS option. Raw measurement data files, which have a `.raw` extension, store raw voltage data for every measurement taken while the raw file is selected. Each raw measurement data file is associated with one measurement data file and uses the identical base name as the measurement data file.

The data file header contains file and sample property information that is defined when the measurement data file is created. Information written to the data file header cannot be subsequently changed in PPMS MultiVu.

Sample measurement data is saved only if a measurement data file is selected. Raw voltage data is saved only if a measurement data file is selected *and* the software is prompted to capture raw voltage data. Data is saved to only the selected data file or files. The **Datafile** tab in the ACMS control center (see figure 6-1) indicates which data file or files will save measurement data. If no measurement data file has been selected, the **Path**, **Name**, and **Title** panels in the **Datafile** tab are blank.

Data files may be viewed in several different formats. The *Physical Property Measurement System: PPMS MultiVu Application User's Manual* discusses the data file format and the multiple data-viewing formats in detail.

6.4.1 Creating an ACMS Measurement Data File

1. Select the **Datafile** tab in the ACMS control center. Refer to figure 6-1.
The **Name** panel in the **Datafile** tab indicates which measurement data file is selected to store sample measurement data. The **Path** panel identifies the location of the file. The **Title** panel lists the title of the graph view of the file. All three panels are blank if a measurement data file is not selected. Measurement data is saved *only* if a measurement data file is selected.
A check mark in the **Log Raw Data** check box indicates that raw voltage data will be saved to a raw measurement data file. Raw voltage data is saved only if a measurement data file is selected *and* the **Log Raw Data** check box is enabled.
2. Select the **Browse** button. The **ACMS Select Existing or New Data File** dialog box opens. The dialog box lists all existing data files.
3. Select the drive and directory where the new data files will reside, if necessary. The default directory to which PPMS MultiVu writes data files is C:\QdPpms\Data.
4. Use the **File name** text box in the **ACMS Select Existing or New Data File** dialog box to enter the name of the new data file. If you enter the name of an existing data file or double-click on an existing file, that file will be overwritten.
5. Select **Open**. A pop-up dialog appears and prompts you to specify the data file title and the highest harmonic that will be recorded to the new data file.
6. Specify a title for the graph view of the data file, if you like. The title appears above the plot of the file. Specifying a title for the graph view is not mandatory.
7. Specify the highest harmonic that will be recorded to the data file. The harmonic is the higher frequency effect of a measurement and may have physical significance for certain samples. The default harmonic value is 1. You may select any number from 1 to 10.
8. Select **OK** in the pop-up dialog. The **ACMS Sample Properties** dialog box opens.
9. Define the sample parameters and the values of the parameters, and then select **OK**. There are no fixed sample properties for ACMS measurements, and the ACMS software does not use the sample properties you specify in order to determine any data.
When you select **OK** in the **ACMS Sample Properties** dialog box, the **Datafile** tab appears again. The **Path**, **Name**, and **Title** panels now identify the data file you have just created.
10. Enable the **Log Raw Data** check box if you want to save the raw voltage data to a raw measurement data file, or disable the check box if you do not want to save the raw voltage data. The raw measurement data file will have the identical base name as the measurement data file.



Saving raw voltage data is an option but can be useful under certain conditions. Be aware that raw data files are very large because each individual data point is stored as an entire record and no data reduction is performed. Raw data is saved to a separate raw data file that has the identical base name as the measurement data file, but a `.raw` file extension instead of a `.dat` extension.

Once you select a data file or data files, all subsequent measurement data is saved to those files until you use the ACMS software to either select new files or no file.

6.4.2 Adding a Comment to an ACMS Measurement Data File

You may append a comment to the ACMS measurement data file that is selected to store measurement data. Comments are useful to record changes in operation or any other type of information about the experiment that it would be helpful for you or for anyone else who might read the data file to know. A comment may be a string of unlimited length. The quotation mark (") is not permitted in comments.

You may append a comment to the data file immediately, or you may include the comment in a sequence so that the comment is appended to the data file when the sequence runs.

- To append a comment to the data file immediately, select the **Comment** button that is in the **Datafile** tab in the ACMS control center (see figure 6-1), and then enter the comment and select **OK**.
- To append a comment to the data file at a later time, select the **Datafile Comment** sequence command, which is in the **Measurement Commands** group in the sequence command bar, and then enter the comment and select **OK**. The comment appears in the sequence editor, but is not added to the data file until the sequence runs.

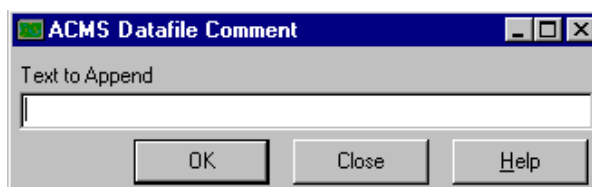

Figure 6-7. ACMS Datafile Comment Dialog Box

To view comments that have been added to the selected data file, you open the raw data view of the file and scroll down through the data until you find the comments.

6.4.3 Changing ACMS Data Files during a Sequence Run

During a sequence run, you may prompt the ACMS software to save sequence measurement data to new or different data files or to stop saving raw voltage data to a raw measurement data file. The **New Datafile** sequence command instructs PPMS MultiVu to start saving data to whatever file or files are selected by **New Datafile**. The **New Datafile** command is in the **Measurement Commands** group in the sequence command bar.

Selecting the **New Datafile** command opens the **Change Datafile** dialog box (see figure 6-8). You use the **Datafile** tab in the **Change Datafile** dialog box to select a measurement data file and, if you want to record raw voltage data, to prompt PPMS MultiVu to save raw data to the measurement data file's associated raw data file. Deselecting the **Record Raw Data** check box prompts PPMS MultiVu to stop saving raw data.

You may use **New Datafile** to select an existing data file or to create a new data file. Refer to section 6.4.1 to review the procedures you follow to create a new data file.

Before you select the data file to which you will append data, you should open the **Sample** tab in the **Change Datafile** dialog box. The **Sample** tab, which is identical to the **Properties** tab in the ACMS control center, lists the sample property information stored in the header of the selected data file. Choose a different data file if the sample property information does not match your sample. If you append data to a file, you cannot change the title of the file, the value of the highest harmonic that is recorded to the file, or any of the sample property information that is stored in the data file header.

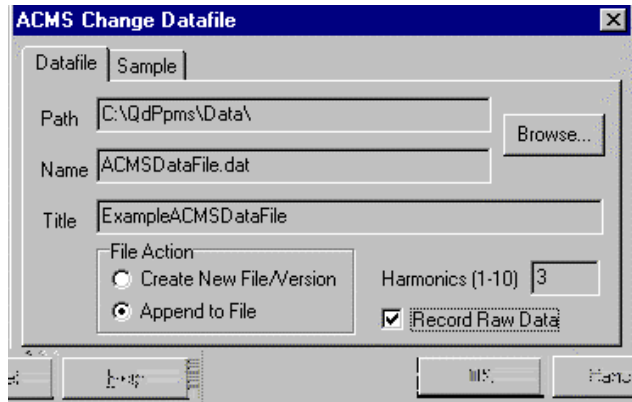

Error and Warning Messages

A.1 Introduction

This appendix contains the following information:

- Section A.2 lists the system start-up error and warning messages.
- Section A.3 lists the general system error and warning messages.
- Section A.4 lists the sample centering error and warning messages.
- Section A.5 lists the AC measurement error and warning messages.
- Section A.6 lists the DC measurement error and warning messages.
- Section A.7 lists the DSP I/O error and warning messages.
- Section A.8 lists the servo controller error and warning messages.

Warning messages appear on a yellow background in the status bar that is at the bottom of the ACMS control center. Error messages appear on a red background. Warning messages indicate a minor hardware or software problem. If a measurement is in progress when a warning message appears, the measurement results will be suspect. Error messages indicate a serious hardware or software problem. If a measurement is in progress when an error message appears, the measurement results will be wrong.

If an error message appears, you should investigate the cause of the problem before you use the system to perform any other operations. If the error message indicates a software problem, you should restart PPMS MultiVu and reactivate the ACMS option.

A.2 System Start-Up Error and Warning Messages

MESSAGE	TYPE	EXPLANATION
DSP failure to initialize.	Error	Application failed to reset DSP after several tries.
DSP failure to initialize, check connections.	Error	Application cannot communicate with DSP.
DSP failed to initialize, going offline.	Error	Application abandoned attempts to communicate with DSP. DSP will be put into simulation mode.
ACMS DSP running in simulation mode.	Warning	Application is simulating DSP.
ACMS transport running in simulation mode.	Warning	Application is simulating servo transport.
DC calibration file missing. DC measures are not calibrated.	Warning	dc-emu.cal file is missing. Computed DC emu values will be wrong.
Missing sample thermometer calibration file: <CalFile>.	Warning	dc-therm.cal file is missing. Application will use system thermometer.
Sample thermometer is not working, using system thermometer.	Warning	Application cannot read sample thermometer and is using system thermometer for temperature readings, thus causing inaccuracies in results.

A.3 General Error and Warning Messages

MESSAGE	TYPE	EXPLANATION
Set temperature (T) is over 350 K, may harm coilset.	Error	Application has detected a set temperature greater then 350 K.
No signal detected for this measurement.	Error	A zero-amplitude signal was read by DSP. Check connections.
Signal too large at lowest gain.	Error	Signal amplitude exceeded 90% of maximum voltage input of DSP.
Signal too large at selected gain.	Error	Signal amplitude exceeded 90% of maximum voltage input of DSP.
Small signal at highest gain.	Warning	Signal amplitude is less then 1% of maximum voltage input of DSP.
Small signal at selected gain.	Warning	Signal amplitude is less then 1% of maximum voltage input of DSP.
Servo travel blocked.	Warning	Application unable to move servo to new position.
Unable to change datafile, not an ACMS datafile <file>.	Warning	New Datafile sequence command found non-ACMS data file.
Unable to change datafile, incorrect ACMS version <file>.	Warning	New Datafile sequence command found old ACMS data file.

A.4 Centering Error and Warning Messages

MESSAGE	TYPE	EXPLANATION
Cannot start AC centering.	Warning	Error occurred in starting AC centering.
Cannot start DC centering.	Warning	Error occurred in starting DC centering.
Unable to locate sample.	Warning	Error occurred in the locate data and the locate was cancelled.

A.5 AC Measurement Error and Warning Messages

MESSAGE	TYPE	EXPLANATION
Measurement not taken due to errors.	Error	Previous errors have invalidated measurement.
Measurement did not complete, canceling.	Error	A timeout from previous message indicates measurement will be cancelled.
Cannot set requested drive, using <h> Oe.	Warning	Requested drive is too large for coil. Smaller drive will be used.
Unable to move sample to required position.	Warning	Application unable to move sample to top, bottom, or center.
Internal math error: drive phase or consistency check failed.	Warning	Unexpected error indicates that measurement is bad.
Unable to apply calibration correction --- no signal detected.	Warning	No signal detected for measurement.
Measurement unexpectedly already in progress, waiting . . .	Warning	DSP is completing a measurement (may be a serious error).

A.6 DC Measurement Error and Warning Messages

MESSAGE	TYPE	EXPLANATION
Incorrect DC scans count. Requested = <m>, Actual = <n>.	Error	Servo motor made too few (or too many) scans of sample.
Sample is too far off-center for DC measurements.	Error	Measured signal was trimmed by servo limits and is unusable.
Cannot calculate sample position, using zero.	Warning	DC center signal was too poor to use to determine center position.
Using nearest sample position in accessible region <x> to <y>.	Warning	Requested sample travel is outside servo motor limits.
No data measured for DC measurement.	Warning	No signal detected for DC measurement.

A.7 DSP I/O Error and Warning Messages

MESSAGE	TYPE	EXPLANATION
DSP unable to run reliably, going offline.	Error	Problem occurred with DSP or with GPIB communications. May be random and may be correctable or recoverable.
DSP discarding measurement.	Error	Problem occurred with DSP or with GPIB communications. May be random and may be correctable or recoverable.
DSP cannot be cleared.	Warning	Application deactivate cannot clear DSP.
DSP internal consistency failed.	Warning	Problem occurred with DSP or with GPIB communications. May be random and may be correctable or recoverable.
DSP error detected and corrected.	Warning	Problem occurred with DSP or with GPIB communications. May be random and may be correctable or recoverable.
DSP wrong packet length returned.	Warning	Problem occurred with DSP or with GPIB communications. May be random and may be correctable or recoverable.
DSP incorrect checksum, re-fetching packet.	Warning	Problem occurred with DSP or with GPIB communications. May be random and may be correctable or recoverable.
DSP SendRead packet length, requested = 1, actual = <w>.	Warning	Problem occurred with DSP or with GPIB communications. May be random and may be correctable or recoverable.
DSP unable to get status.	Warning	Problem occurred with DSP or with GPIB communications. May be random and may be correctable or recoverable.

A.8 Servo Controller Error and Warning Messages

The following are exception dialogs the application might display during servo controller initialization:

- *Could not open port
- *Could not read CommState
- *Could not set CommState
- *Could not set DTR
- *Could not set CommTimeouts
- *Could not setup EscapeCommFunction
- *Could not set baud rate
- *Could not initialize servo-controller

MESSAGE	TYPE	EXPLANATION
Servo controller unable to recover.	Error	Errors have forced application to abandon communications with servo.
Unrecoverable servo controller error, unable to continue experiment!	Error	Application will halt all measurement activity until user corrects the problem.
Servo controller is not connected.	Error	Measurement attempted to use servo and servo was off-line.
Servo has been reset, initializing servo . . .	Warning	Application detected that servo was reset (perhaps a power problem) and is attempting to re-initialize servo.
Servo controller error: <error>, retrying . . .	Warning	This error can occur in servo communications. Application will attempt to retry for a limited time before abandoning communication.
Servo controller error: <error>.	Warning	This error can occur in servo communications. Application will attempt to retry for a limited time before abandoning communication.

The following servo errors are returned by the application:

Servo Not Connected
 RS232 Read Failure
 Read Timeout
 No Reply
 RS232 Write Failure
 Servo Move Failure
 Cannot Communicate to Servo
 No Reply to Escape
 Servo Move Inaccurate
 Servo Reset Occurred
 Servo Memory Loss Occurred
 Servo Register Loss Occurred

The following servo errors are returned by the servo controller:

Argument Error
 Invalid Command
 Invalid Macro Cmd
 Macro Arg Err
 Macro Not Defined
 Macro Out of Range
 Out Of Macro Space
 Def Macro in Macro
 Def Macro when Servo Enabled
 Macro Jump Error
 Out of Macro Heap Space
 Macro Must be 1st Command

References

- Quantum Design. 2000. *Physical Property Measurement System: Hardware Manual*.
- . 2000. *Physical Property Measurement System: PPMS MultiVu Application User's Manual*.
- . 1996. Service note 1084-302, Calibration Procedure for the PPMS P500 AC Susceptibility and DC Magnetization Option (ACMS).
- . 1999. *Using the Fiber Optic Sample Holder (FOSH) for the ACMS*.

Index

AC 1-4, 5-5

AC board, 1-4, 5-5

AC centering

 advisability of, 4-5

 comparison with DC centering, 4-3, 4-5

 in immediate mode, procedures for, 4-7–4-8

 operating modes, 4-4

 plot, example of, 4-7

 process, 4-6, 4-7

 in sequence mode, procedures for, 4-8

 warning messages, A-3

AC excitation modes, 6-6

AC, field amplitude, 4-16

ACMS control center

 measurement command buttons, 6-6

 overview, 6-1

 status bar, 6-2

 tabs, 6-2–6-6

ACMS insert

 adjusting keyed interface, 5-2

 function, 1-1, 5-2. *See also* Detection coils; Drive coil

 illustration, 1-3, 5-2

 installing

 in PPMS, 2-1, 2-2

 sample in, 3-4

 warming, 4-16

 removing, 2-5

 storing, 5-2

AcmsLog file, 6-7

ACMS measurement data files

 adding comment to, 6-9

 automa..00--aopLp- staing, sequencedata , -16 achangng, durng, sequencedrun 6-9 TT/TT7 1 Tf15.3933 0TcD0.Tc0.Tw@130jT/TT2 1 Tf0.59

- Baffled rod, on ACMS insert, 5-2
- Bucket, for ACMS sample holder, 5-4
- Burst excitation mode, 6-6
- Cables
 - connections, illustration of, 2-4
 - description, 5-6
- Calibration coils, 1-2, 1-3, 4-2
- Centering. *See* AC centering; DC centering
- Coil set, on ACMS insert, 5-2. *See also* Detection coils; Drive coil
- Comment, adding to data file, 6-9
- Compensation coil
 - function, 1-2
 - illustration, 1-3
- Configure tab, 6-6
- Connections, illustration of, 2-4
- Continuous excitation mode, 6-6
- Control center. *See* ACMS control center
- Correlating detection technique, 6-6
- Cryogenics, safety precautions for, 1-5
- Datafile Comment sequence command, 6-9
- Data file header, 6-7
- Data files
 - adding comment to, 6-9
 - changing during sequence run, 6-9–6-10
 - creating, 6-8
 - default directory, 6-8
 - saving data to, 4-4, 6-2, 6-7
 - selected, identified in Datafile tab, 6-2, 6-7
 - types, 6-7
 - viewing formats, 6-7
- Datafile tab, 6-2
- DC-AC offset, 4-6, 4-7
- DC centering
 - advisability of, 4-5
 - comparison with AC centering, 4-3, 4-5
 - in immediate mode, procedures for, 4-8–4-9
 - operating modes, 4-4
 - plot, example of, 4-9
 - process, 4-6–4-7
 - in sequence mode, procedures for, 4-9
 - warning messages, A-3
- DC extraction. *See* DC centering
- DC magnetization measurements
 - centering sample prior to taking, 4-11
 - comparison with AC measurements, 4-3
 - creating calibration file for, 6-5
 - error messages, A-1, A-4
 - in immediate mode, procedures for, 4-17
 - operating modes, 4-4
 - plot, example of, 4-17
 - process, 4-1, 4-3. *See also* ACMS option: Probe magnetics
 - reviewing results in ACMS status log, 6-7
 - in sequence mode, procedures for, 4-18
 - warning messages, A-1, A-4
- DC servo motor. *See* Servo motor
- Detection coils
 - function, 1-2, 1-3
 - illustration, 1-3
 - and sample centering. *See* AC centering; DC centering
- Detection techniques, 6-6
- Diagnostic mode, 6-5
- Drive coil
 - excitation modes, 6-6
 - function, 1-2
 - illustration, 1-3
- DSP
 - testing when ACMS is activated, 6-6
 - warning messages, A-5
- Eddy Current Heating, 4-16
- Error messages, A-1–A-6
- Five-point measurement
 - process, 4-2
 - suggested use, 4-12
- Fixed range, 4-12, 4-15, 1-18-4-19
- Frequency spacing modes, 4-15
- Hardware
 - installing, 2-1–2-4
 - overview, 5-1
 - removing, 2-5
- Harmonic, highest, saving to data file, 6-2, 6-8
- High-Vacuum option, effect on transport installation, 2-3
- Immediate mode
 - centering. *See* AC centering; DC centering
 - comparison with sequence mode, 4-4
 - measurements. *See* AC susceptibility measurements; DC magnetization measurements
- Installation
 - hardware, 2-1–2-4
 - sample, 3-4
- Integrating detection technique, 6-6
- Magnet, safety precautions for, 1-5
- Maintenance
 - ACMS insert, 5-2
 - ACMS sample holder, 5-4
 - ACMS sample transport, 5-3
- Measurement data, saving. *See* ACMS measurement data files: Saving data to
- Measurements. *See* AC susceptibility measurements; DC magnetization measurements
- Measure modes, 4-12-4-19
- Model 6000 PPMS Controller
 - ACMS cables connected to, 5-6
 - housing AC board, 1-4, 5-5
- Model 6000/servo controller cable, 5-6
- New Datafile sequence command, 6-9–6-10

- Palladium calibration sample, 5-1
- PPMS sample chamber, warming, 4-16
- Preamp cable, 5-6
- Primary scan mode, 4-14
- Properties tab, 6-4

- Ranging modes, 4-12,4-18-4-19
- Raw voltage data
 - saving, 6-2
 - switching save option during sequence run, 6-9–6-10
- Recalibration commands, 6-5

- Safety precautions, 1-5–1-6
- Sample
 - centering. *See* AC centering; DC centering
 - characteristics, influencing measurement method, 4-3
 - installing, 3-4
 - measuring. *See* AC susceptibility measurements; DC magnetization measurements
 - mounting
 - on ACMS sample holder, 3-1, 3-2
 - on drinking straw, 3-1, 3-3
 - options, list of, 5-4
 - moving independently, 4-10, 5-3, 6-5
 - property data, displayed in Properties tab, 6-4
 - removing, 3-5
 - specifying location of, 4-9
 - types, suitable for ACMS sample holder, 5-4
- Sample holder. *See* ACMS sample holder
- Sample rod assemblies, for ACMS sample holder, 5-4
- Sample tab, 6-3. *See also* Sample: Installing
- Sample transport. *See* ACMS sample transport
- Sample transport/servo controller cable, 5-6
- Sequence mode
 - centering. *See* AC centering; DC centering
 - comparison with sequence mode, 4-4
 - measurements. *See* AC susceptibility measurements; DC magnetization measurements
- Servo controller
 - error messages, A-6
 - exception dialogs, A-5
 - function, 1-4, 5-5
 - warning messages, A-6
- Servo motor
 - controlling movement of, 5-3, 6-5
 - moving sample, 1-1, 1-3
 - and sample centering, 4-5
 - turning on, 6-3
- Software, overview of, 6-1. *See also* ACMS control center; ACMS measurement data files; ACMS raw measurement data files; ACMS status log
- Status log. *See* ACMS status log
- Sticky autorange, 4-12
- System start-up warning messages, A-2

- Temperature
 - changes, effect on centering, 4-5, 4-11
 - maximum, 1-2, 4-16
 - rise, 4-16
- Thermometers, 1-4

- Warning messages, A-1–A-6
- Waveform reference, 6-4
- Waveforms tab,4-13,4-18, 6-4